

# OCULAR INSTRUMENTS PRODUCT CATALOG



A new world in sight.  Ocular<sup>®</sup>  
Instruments

# Vision



It is both our business and our guiding principle. For over 40 years we have stayed focused on a single ideal: to create and produce ophthalmic lenses of unparalleled sharpness and clarity.

And while we have continually challenged ourselves to create breakthrough lens systems that take the forefront of the ophthalmic industry, we are at the same time committed to continually improving the features and durability of all our product lines.

Our personal focus, however, has always been clearly on you.

We are not just driven. We are customer driven.

We believe our quest for higher performance and the pursuit of perfection is why so many leading doctors consistently choose the products of Ocular Instruments.



# TABLE OF CONTENTS

COLOR-CODED REFERENCE TABS >

■ Laser Lenses . . . . .	4
■ Laser Photocoagulation Lenses . . . . .	4
■ YAG Laser Photodisruption and SLT Lenses . . . . .	14
■ Diagnostic Lenses . . . . .	17
■ Indirect Diagnostic/Laser Lenses . . . . .	24
■ Wide Angle Surgical Systems . . . . .	36
■ Surgical Lenses . . . . .	41
■ Scanning Laser Ophthalmoscope (SLO) Lenses . . . . .	51
■ Research Lenses . . . . .	52
■ Tonometers . . . . .	53
■ Educational Aids . . . . .	55
■ Cases . . . . .	56
■ Lens Accessories . . . . .	57
■ Cleaning Methods . . . . .	60
■ Laserlight® Anti-reflective Coatings . . . . .	62
■ Lens Materials . . . . .	62
■ Ordering Information . . . . .	63
■ Alphabetical Index . . . . .	64
■ Contact Information . . . . .	67



Products listed in this catalog are certified except Landers and Cobo Temporary Keratoprosthesis.

# SUBSPECIALTY INDEX

## CATARACT

SECTION	LENS
Photocoagulation	Hoskins Nylon Suture Layden Suture Lysis Mandelkorn Suture Lysis Ritch Nylon Suture
Surgical	Double Mirror Surgical Gonio Mori Upright Surgical Gonio Osher Gonio Post Pole Osher Surgical Kit Swan Jacob Gonio Thorpe Gonio
Tonometers	Kasaby Barraquer
YAG Laser	Abraham Capsulotomy Mandelkorn Irid/Caps Peyman G Capsulotomy

## CORNEA

SECTION	LENS
Surgical	Cobo Temp Kerato Landers WF Temp Kerato

## GENERAL EXAMINATION

SECTION	LENS
Diagnostic	1X Four Mirror Autoclavable Gonio Four Mirror Autoclavable Gonio Fundus Four Mirror Mini Gonio Gaasterland 1X Four Mirror Gaasterland Four Mirror Gonio Karickhoff Khaw 1X Direct View Gonio Khaw 4D Direct View Gonio Koeppel Magna View Gonio Single Mirror Gonio Thorpe Four Mirror Gonio Three Mirror Three Mirror Autoclavable Three Mirror HD Two Mirror Gonio
Indirect Diag/Laser	BIO: Various Powers Slit Lamp: Various Powers
Photocoagulation	1.5X Magna View Gonio Four Mirror Mini Gonio Fundus Karickhoff Magna View Gonio Magna View Two Mirror Gonio Single Mirror Gonio Thorpe Four Mirror Gonio Three Mirror Three Mirror HD Two Mirror Gonio Yannuzzi Fundus
YAG Laser	Magna View Gonio

## GLAUCOMA

SECTION	LENS
Diagnostic	1X Four Mirror Autoclavable Gonio Four Mirror Autoclavable Gaasterland 1X Four Mirror Gaasterland Four Mirror Gonio Karickhoff Khaw 1X Direct View Gonio Koeppel Magna View Gonio Posner Gonioprism Sussman Gonioprism Three Mirror Three Mirror HD
Gonio	Thorpe Four Mirror Gonio
Photocoagulation	1.5X Magna View Gonio Abraham Iridectomy Four Mirror Mini Gonio Gaasterland 1X Four Mirror Hoskins Nylon Suture Layden Suture Lysis Magna View Gonio Magna View Two Mirror Gonio Mandelkorn Suture Lysis Mori Upright Surgical Gonio Ritch Nylon Suture Ritch Trabeculoplasty Single Mirror Gonio Thorpe Four Mirror Gonio Three Mirror Three Mirror HD Two Mirror Gonio Wise Iridotomy
Surgical	Double Mirror Surgical Gonio Hill Surgical Gonioprism Hoskins-Barkan Goniotomy Khaw Surgical Gonioprism Mori Upright Surgical Gonio Ritch Panoramic Surgical Gonioprism Swan Jacob Gonio Thorpe Gonio Wells Suture Manipulator
YAG Laser	Abraham Iridectomy Latina SLT Gonio Magna View Gonio Mandelkorn Irid/Caps Pollack Irid/Gonio

## REFRACTIVE

SECTION	LENS
Tonometers	Barraquer

## RESEARCH

SECTION	LENS
	HRA 20D Lens Adapter Kaufman Gonio Mouse Fundus Mouse Gonio Rat Fundus

## RETINAL EXAM & LASER

SECTION	LENS
Diagnostic	Fundus Karickhoff Three Mirror Three Mirror HD
Indirect Diag/Laser	BIO: Various Powers Landers ROP Lens Attachment Saxena Retinal Grid 428 Saxena Retinal Grid 520 Slit Lamp: Various Powers
Photocoagulation	Fundus Karickhoff Mainster High Mag Mainster PRP 165 Mainster (Std) Focal/Grid Mainster Wide Field PDT PDT 1.6X ProRetina 120 Reichel-Mainster 1X Reichel-Mainster 2X Three Mirror Three Mirror HD Yannuzzi Fundus
SLO	Lee-Mainster SLO Starengi Wide Field

## VITREO-RETINAL SURGERY

SECTION	LENS
Indirect Laser	20D, 28D Autoclavable Autoclavable Lens Stand
Surgical	Disposable Vitrectomy Hexagonal Handle Vitr Landers Biconcave Vitr Landers Vit Ring System Landers WF Temp Kerato Machemer Magnifying Vitr Pediatric Vitrectomy Peyman-Green Vitr Peyman Pediatric Wide Field Peyman Wide Field Vitr Reichel Viscous Contact System Vitrectomy Lens Holder Vitrectomy Rings
Surgical Viewing Systems	Inverter Vitrectomy System Landers Equatorial Landers SVS Landers Wide Field Peyman-Wessels-Landers 132D Woldoff High Mag
Tonometers	Barraquer
YAG Laser	Karickhoff 21mm Vitreous Karickhoff Off-Axis Vitreous Peyman 12.5, 18, 25mm

# LASER PHOTOCOAGULATION LENSES

## RETINA LENS COMPARISON CHART

LENS		PRORETINA 120 PB <sup>(3)</sup>	REICHEL- MAINSTER 2X	PRP 165	PDT 1.6X	WIDE FIELD	REICHEL- MAINSTER 1X	(STANDARD) FOCAL/ GRID <sup>(4)</sup>	PEDIATRIC REICHEL- MAINSTER 1X	HIGH MAG
IMAGE MAGNIFICATION		.50X	.50X	.51X	.63X	.68X	.95X	.96X	1.08X	1.25X
LASER SPOT MAGNIFICATION FACTOR <sup>(2)</sup>		2.00X	2.00X	1.96X	1.60X	1.50X	1.05X	1.05X	.93X	.80X
STATIC FIELD OF VIEW		120°	117°	165°	120°	118°	102°	90°	98°	75°
DYNAMIC FIELD OF VIEW		136°	142°	180°	133°	127°	133°	121°	126°	88°
RETINAL DISORDER <sup>(1)</sup>	PROCEDURE									
NVD, NVE or NVI	PRP, Clear Media	■ ■	■ ■	■ ■ ■	■ ■	■ ■	■ ■	■	-	-
NVD, NVE or NVI	PRP, Vitreous Hemorrhage	■ ■ ■	■ ■ ■	■ ■	■ ■ ■	■ ■ ■	■ ■	■	-	-
Macular Edema	Focal + Grid	■	■ ■	■	■	■	■ ■ ■	■ ■ ■	■ ■ ■	■ ■
CNV in ARMD or OHS	Focal	-	-	-	-	-	■ ■ ■	■ ■ ■	-	■ ■ ■
	PDT, TTT	■	■ ■ ■	■	■ ■ ■	■ ■ ■	■ ■ ■	■ ■ ■	-	■ ■ ■
Retinal Holes	Peripheral	■	■	■ ■ ■	■	■	■	-	-	-

■ ■ ■ OPTIMAL    ■ ■ VERY USEFUL    ■ USEFUL    - NOT USEFUL

<sup>(1)</sup> NVD, NVE, NVI: neovascularization - disc, retina elsewhere, iris; CNV: choroidal neovascularization; ARMD: age-related macular degeneration; OHS: ocular histoplasmosis syndrome.

<sup>(2)</sup> Multiply the laser photocoagulator spot size setting by this magnification factor to calculate the retinal spot size produced by each lens.

<sup>(3)</sup> The ProRetina's tubular design facilitates examination and treatment of patients with prominent brows. It also allows easy lens manipulation for examination and treatment of the retinal periphery.

<sup>(4)</sup> Focal/Grid is the new name for the Mainster Standard.

ALL LASER LENSES USE CLEANING METHOD 1 \* No methylcellulose required



### OCULAR MAINSTER PRP 165

Widest field of view available for panretinal photocoagulation. Unique optical design provides clear, bright image across the entire field. Light weight. Securefit® flange for easy manipulation. Now available with our NEW Laserlight® HD anti-reflective coating. See Coatings and Materials (page 62) for more details.

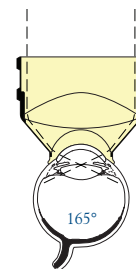

Product Code	Image Mag.	Laser Spot Mag.	Contact Diam.	Lens Height	Static FOV	Dynamic FOV
OMRA-PRP-165	.51x	1.96x	17.5mm	28mm	165°	180°
OMRA-PRP-165-2*	.51x	1.96x	16.5mm	27.5mm	165°	180°



### OCULAR MAINSTER WIDE FIELD

For panretinal photocoagulation in proliferative diabetic retinopathy. Excellent ophthalmoscopic resolution. Image binocularity across the entire field of view. Allows a very wide range of slit lamp magnifications to be used. Now available with our NEW Laserlight® HD anti-reflective coating. See Coatings and Materials (page 62) for more details.

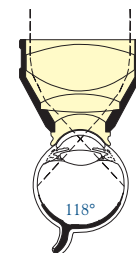

Product Code	Image Mag.	Laser Spot Mag.	Contact Diam.	Lens Height	Static FOV	Dynamic FOV
OMRA-WF	.68x	1.50x	15.5mm	28mm	118°	127°
OMRA-WF-2*	.68x	1.50x	12mm	26.5mm	118°	127°

Journal references: AJO, Vol. 117, pp 442-446, April 1994  
American Academy of Ophthalmology, Vitreoretinal Update, Subspecialty Day 1999



### OCULAR REICHEL-MAINSTER 1X RETINA

Superior optical resolution for detecting subtle fundus details such as retinal thickening and serous detachments. High axial and lateral magnifications facilitate the diagnosis and treatment of macular and retinal vascular disorders. Broad field of view provides versatility for focal, grid and panretinal photocoagulation. Ideal for photodynamic therapy and for treating choroidal neovascularization, diabetic retinopathy and retinal vascular occlusion. The ORMR-1X-P has a smaller contact diameter for pediatric patients. Now available with our NEW Laserlight® HD anti-reflective coating. See Coatings and Materials (page 62) for more details.

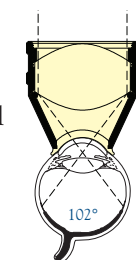

Product Code	Image Mag.	Laser Spot Mag.	Contact Diam.	Lens Height	Static FOV	Dynamic FOV
ORMR-1X	.95x	1.05x	16.5mm	30mm	102°	133°
ORMR-1X-2*	.95x	1.05x	15mm	29.5mm	102°	133°
ORMR-1X-P	1.08x	.93x	15mm	31mm	98°	126°

Journal reference: Seminars in Ophthalmology, 2001, Vol. 16, No. 2, pp 60-65.

Ocular Argon/Diode Lenses come with Laserlight® coating for maximum brightness and easy cleaning, see page 62.

## OCULAR MAINSTER (STANDARD) FOCAL/GRID

Designed for focal and grid laser treatment from the posterior pole to the mid-periphery. Excellent for diagnosis and treatment of macular edema, branch retinal vein occlusion, choroidal neovascularization in aging macular degeneration, and presumed ocular histoplasmosis. High resolution, high magnification image allows appreciation of subtle intra-retinal details and retinal thickening. Now available with our NEW Laserlight® HD anti-reflective coating. See Coatings and Materials (page 62) for more details.

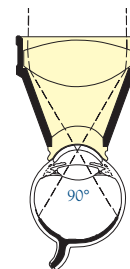

Product Code	Image Mag.	Laser Spot Mag.	Contact Diam.	Lens Height	Static FOV	Dynamic FOV
OMRA-S	.96x	1.05x	15.5mm	32.5mm	90°	121°
OMRA-S-2*	.96x	1.05x	12mm	31mm	90°	121°

Journal references: *Ophthalmology Times*, Vol. 15, No. 18, Sep 15, 1990; *British Journal of Ophthalmology*, Vol. 74, No. 3, pp 177-179, Mar 1990; *Archives of Ophthalmology*, Vol. 106, p 1640, Dec 1988

## OCULAR PRORETINA 120 PB

High resolution aspheric design for panretinal photocoagulation. Streamlined shape simplifies treatment of patients with prominent brows and allows easy lens manipulation to examine and treat the retinal periphery. The shape and features of this lens compares to the traditional Rodenstock Pan Fundus Lens. Now available with our NEW Laserlight® HD anti-reflective coating. See Coatings and Materials (page 62) for more details.



Product Code	Image Mag.	Laser Spot Mag.	Contact Diam.	Lens Height	Static FOV	Dynamic FOV
OPR-120	.50x	2.00x	16mm	35.5mm	120°	136°
OPR-120-2*	.50x	2.00x	14mm	35mm	120°	136°

## OCULAR REICHEL-MAINSTER 2X

Superior optical resolution for detecting subtle fundus details such as retinal thickening and serous detachments. Outstanding imaging performance through hazy ocular media. Broad field of view provides versatility for focal, grid and panretinal photocoagulation. Ideal for photodynamic therapy and for treating choroidal neovascularization, diabetic retinopathy and retinal vascular occlusion. Now available with our NEW Laserlight® HD anti-reflective coating. See Coatings and Materials (page 62) for more details.

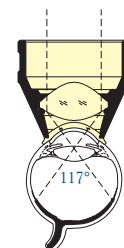

Product Code	Image Mag.	Laser Spot Mag.	Contact Diam.	Lens Height	Static FOV	Dynamic FOV
ORMR-2X	.50x	2.00x	16.5mm	27.5mm	117°	142°
ORMR-2X-2*	.50x	2.00x	15.5mm	27mm	117°	142°

ALL LASER LENSES USE CLEANING METHOD 1 \* No methylcellulose required



### OCULAR PDT 1.6X

Exceptional lens for treatment of macular degeneration. Larger treatment area with high resolution. Unique design for ease of use and optimal image contrast. Now available with our NEW Laserlight® HD anti-reflective coating. See Coatings and Materials (page 62) for more details.

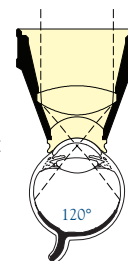

Product Code	Image Mag.	Laser Spot Mag.	Contact Diam.	Lens Height	Static FOV	Dynamic FOV
OPDT	.63x	1.60x	15.5mm	32.5mm	120°	133°
OPDT-2*	.63x	1.60x	12mm	31mm	120°	133°



### OCULAR MAINSTER HIGH MAGNIFICATION

Very high magnification for detecting and treating macular problems. Facilitates location of subtle vascular landmarks during macular photocoagulation that may be apparent angiographically but are hard to find without superior magnification.

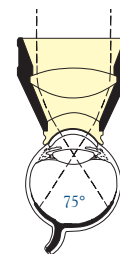

Product Code	Image Mag.	Laser Spot Mag.	Contact Diam.	Lens Height	Static FOV	Dynamic FOV
OMRA-HM	1.25x	.80x	15.5mm	27.5mm	75°	88°
OMRA-HM-2*	1.25x	.80x	12mm	26.5mm	75°	88°

Ocular Argon/Diode Lenses come with Laserlight® coating for maximum brightness and easy cleaning, see page 62.





## OCULAR THREE MIRROR UNIVERSAL

This classic "Goldmann" type lens has three mirrors angled at 59°, 67° and 73° to permit viewing of the fundus and anterior chamber. The posterior pole is viewed through the center of the lens. Many heights and diameters are available. Gonio mag .80x. Gonio laser spot mag 1.25x.

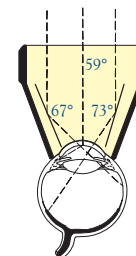

Product Code	Style	Image Mag.	Laser Spot Mag.	Contact Diam.	Lens Height	Static Gonio FOV
OG3MA	Universal	.93x	1.08x	18mm	32mm	140°
OG3MA-2*	NMR	.93x	1.08x	16mm	32mm	140°
OG3MFA	with flange	.93x	1.08x	20mm	33mm	140°
OG3MIA	15mm	.93x	1.08x	15mm	28mm	140°
OG3MPA	17mm	.93x	1.08x	17mm	26mm	140°
OG3MSA	Short	.93x	1.08x	18mm	24mm	140°
OG3MSA-2*	NMR Short	.93x	1.08x	16mm	23mm	140°
OG3MA-13*	NMR Small	.93x	1.08x	13mm	28mm	140°

Fissure

Journal reference: *Optometric Management*, Vol. 35, No. 6, June 2000  
*The Journal of Ophthalmic Photography*, Vol. 26, No. 1, pp. 13-19, Spring 2004

## OCULAR HIGH DEFINITION THREE MIRROR

Provides mirrors for examination of the fundus and the anterior chamber angle. High index glass three mirror lens with our Laserlight® HD anti-reflective coating for maximum light transmission and image brightness. One 64° gonio mirror and two fundus mirrors, 73° and 67°. Fundus images overlap, no "blind spot" in fundus field. Outstanding for laser and diagnostic applications – 15mm or 17mm flange adapters recommended for laser procedures. Compatible with visible and near infrared lasers. Methylcellulose not required.

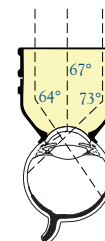

Product Code	Image Mag.	Laser Spot Mag.	Contact Diam.	Lens Height	Static Gonio FOV
OG3MHD-10*	.65x	1.54x	10mm	25.0mm	150°
OG3MHD-15*	.65x	1.54x	15mm	26.5mm	150°
(OG3MHD-10 Lens w/OACF-15 flange)					
OG3MHD-17	.65x	1.54x	17mm	27.5mm	150°
(OG3MHD-10 Lens w/OACF-17 flange; methylcellulose recommended)					

Flanges also sold separately, see accessory section.  
 U.S. Patent #6,767,098

ALL LASER LENSES USE CLEANING METHOD 1 \* No methylcellulose required



### OCULAR KARICKHOFF

Four mirrors plus a central axis view give a complete view of the interior of the eye. Unique "depth dots" mark each mirror at the base for easy orientation. One dot, 62° (anterior chamber angle); two dots, 67° (ora serrata); three dots, 76° (mid-equator); four dots, 80° (mid-peripheral area). The mirrors provide fields of view that overlap completely. Gonio mag .80x. Gonio laser spot mag 1.25x.

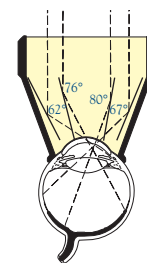

Product Code	Image Mag.	Laser Spot Mag.	Contact Diam.	Lens Height	Static Gonio FOV
OJKA	.93x	1.08x	18mm	30mm	140°
OJKFA (w/flange)	.93x	1.08x	20mm	32.5mm	140°

Journal references: *Optometry Today Supplement*, pp. 23-24, September 1992  
*Optometric Management*, Vol. 35, No. 6, June 2000



### OCULAR ABRAHAM IRIDECTOMY

A 66D magnifying lens for viewing the patient's iris. The power density of the laser beam at the iris is increased 2.5x compared with a flat lens. A 50 micron spot size setting yields a 31 micron spot on the iris. The lens provides additional safety by reducing the power density at the cornea and retina by 2.8x.

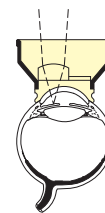

Product Code	Image Mag.	Laser Spot Mag.	Contact Diam.	Lens Height
OAIA	1.60x	.63x	15.5mm	16.5mm

Journal references: *Int'l Ophthalmology Clinic Glaucoma Surgery*, Vol. 21, No. 1, Spring 1981; *Ophthalmic Surgery*, Vol. 11, No. 8, pp. 506-515, August 1980; *Ophthalmic Surgery and Lasers*, Vol. 27, No. 3, pp. 209-227, March 1996; *Perspectives in Ophthalmology*, Vol. 4, No. 2, pp. 129-138, June 1980



### OCULAR WISE IRIDOTOMY-SPHINCTEROTOMY

This lens features a 9mm diameter, 103D magnifying lens strategically aligned to optimize small spot laser delivery. Laser power density at the iris is 2.7 times greater than with an Abraham lens and 6.9 times greater than with a flat lens. Increases treatment efficiency with less energy and shorter burn duration, even on thick brown or light blue irises. Useful with Argon/Diode or Nd:YAG lasers.

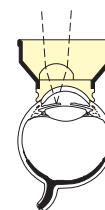

Product Code	Image Mag.	Laser Spot Mag.	Contact Diam.	Lens Height
OWISA	2.60x	.38x	15.5mm	15mm

Journal references: *AJO*, Vol. 101, No. 5, pp. 546-553, May 1986  
*Ophthalmic Surgery*, Vol. 27, No. 3, pp. 209-227, March 1996

Ocular Argon/Diode Lenses come with Laserlight® coating for maximum brightness and easy cleaning, see page 62.

## OCULAR MAGNA VIEW GONIO

The best lens available for gonioscopy and laser trabeculoplasty. One 62° mirror. Tilted anterior surface corrects image and laser beam astigmatism. Unsurpassed resolution. The best lens for anterior chamber angle photography. Can be used on most patients without methylcellulose. Suitable for Argon/Diode or YAG laser treatment. Available with the Ocular Securefit® flange.

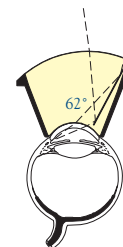

Product Code	Gonio Mag.	Gonio Laser Spot Mag	Contact Diam.	Lens Height	Static Gonio FOV
OMVGL	1.3x	.77x	15mm	23.5mm	160°
OMVGLF (w/flange)	1.3x	.77x	18mm	24.5mm	160°

## NEW OCULAR MAGNA VIEW TWO MIRROR GONIO

In the same spirit as our popular single mirror design, the Two Mirror Magna View gives unsurpassed image resolution and magnification of the anterior chamber angle. The 1.45x gonio magnification provides fine detailed viewing of the anterior chamber angle structures. The second mirror reduces the amount of lens rotation needed to view the total 360° of the anterior chamber. Excellent lens for detailed high resolution digital and traditional photography. Laserlight® HD anti-reflective coating for maximum light transmission and image brightness. Available with the Ocular Securefit® Flange.

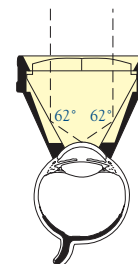

Product Code	Gonio Mag.	Gonio Laser Spot Mag.	Contact Diam.	Lens Height	Static Gonio FOV
OMV2G	1.45x	.69x	15mm	26mm	160°
OMV2GF (w/flange)	1.45x	.69x	18mm	27mm	160°

## NEW OCULAR 1.5X MAGNA VIEW GONIO

This lens features an innovative all glass prism design that eliminates mirror coatings to give the brightest image possible. Only a prism utilizing a total internal reflection (TIR) mirror can deliver 100% of available light back to the observer. The Ocular 1.5X Magna View is based on this concept to provide the brightest image possible. This, coupled with the use of low dispersion glass, computer enhanced optical design, and our advanced Laserlight® HD anti-reflective coating, creates an exceptional gonio lens for diagnosis, treatments and digital documentation of the anterior chamber angle. Available with the Ocular Securefit® Flange.

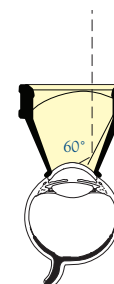

Product Code	Gonio Mag.	Gonio Laser Spot Mag	Contact Diam.	Lens Height	Static Gonio FOV
OMVGL-1.5X	1.5x	.67x	14.5mm	25mm	120°
OMVGLF-1.5X (w/flange)	1.5x	.67x	15.5mm	25mm	120°

Patent Pending

ALL LASER LENSES USE CLEANING METHOD 1 \* No methylcellulose required



**NEW OCULAR SINGLE MIRROR GONIO**

Small size gonio lens with one 62° mirror. Compact knurled ring simplifies 360° viewing and treatment of the anterior chamber angle. The -2 model with NMR-K (Kapetansky) style contact surface design allows gonioscopy and laser trabeculoplasty without methylcellulose. Available with the Ocular Securefit® flange.



Product Code	Gonio Mag.	Gonio Laser Spot Mag.	Contact Diam.	Lens Height	Static Gonio FOV
OSMGA	.80x	1.25x	15mm	21mm	170°
OSMGA-2*	.80x	1.25x	15mm	21mm	170°
OSMGFA (w/flange)	.80x	1.25x	17mm	21.5mm	170°

Journal references: *Ophthalmic Surgery*, Vol. 19, No. 6, pp. 414-416, June 1988; *Optometry Today Supplement*, pp. 23-24, September 1992; *Optometric Management*, Vol. 35, No. 6, June 2000



**NEW OCULAR TWO MIRROR GONIO**

Two opposing 62° mirrors provide a complete view of the anterior chamber angle with only a 180° lens rotation. Methylcellulose and NMR-K (Kapetansky) no methylcellulose designs available. Available with the Ocular Securefit® flange.

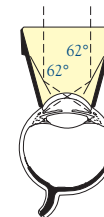

Product Code	Gonio Mag.	Gonio Laser Spot Mag.	Contact Diam.	Lens Height	Static Gonio FOV
O2MA	.80x	1.25x	15mm	21mm	170°
O2MA-2*	.80x	1.25x	15mm	20mm	170°
O2MFA (w/flange)	.80x	1.25x	17mm	21.5mm	170°

Journal reference: *Optometric Management*, Vol. 35, No. 6, June 2000



**OCULAR FOUR MIRROR MINI GONIO**

Four 62° mirrors allow complete observation of the angle with little lens rotation. Small diameter flange is convenient for eyes with small palpebral fissures. Anterior holding ring available in small and large sizes.

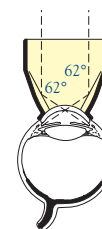

Product Code	Gonio Mag.	Gonio Laser Spot Mag.	Contact Diam.	Lens Height	Ring Diam.	Static Gonio FOV
O4GFA*	.80x	1.25x	15mm	23.5mm	23.5mm	120°
O4GFA-LR*	.80x	1.25x	15mm	27mm	32.5mm	120°

Journal reference: *Optometric Management*, Vol. 35, No. 6, June 2000

Ocular Argon/Diode Lenses come with Laserlight® coating for maximum brightness and easy cleaning, see page 62. \* No methylcellulose required



## OCULAR THORPE FOUR MIRROR GONIO

Four 62° mirrors give a 360° view of the anterior chamber angle with only a slight lens rotation. Posterior pole can be viewed through center of lens. Retina image mag .93x. Retina laser spot mag 1.08x.

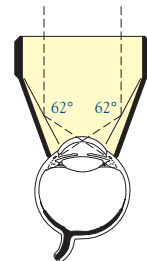

Product Code	Gonio Mag.	Gonio Laser Spot Mag.	Contact Diam.	Lens Height	Static Gonio FOV
OT4MGA	.80x	1.25x	18mm	32mm	150°

Journal reference: *Optometric Management*, Vol. 35, No. 6, June 2000



## OCULAR RITCH TRABECULOPLASTY

Designed with two 59° (round on top) and two 64° mirrors (flat on top). A 1.4x magnifying button is placed over one each of the 59° and 64° mirrors. The magnifying button reduces the laser spot size by 30% and increases the laser power by 2x. The 64° mirror is best for treating the superior 180° of the angle, while the 59° mirror is best for the inferior 180°.

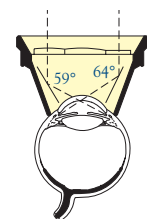

Product Code	Gonio Mag.	Gonio Laser Spot Mag.	Contact Diam.	Lens Height	Static Gonio FOV
ORTA	1.40x	.71x	18mm	23mm	80°

Journal reference: *Review of Ophthalmology*, Vol. 4, No. 6, pp. 97-100, June 1997



## OCULAR HOSKINS NYLON SUTURE

The Hoskins lens is designed for laser suture lysis after trabeculectomy or cataract surgery. The lens compresses conjunctival blood vessels and provides a clear view of the sutures. The flange holds the eye lid out of the way.

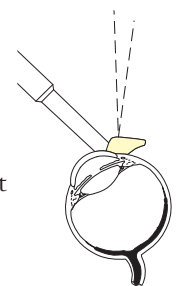

Product Code	Image Mag.	Laser Spot Mag.	Contact Diam.	Handle Length
OHSA	1.20x	.83x	3mm	79mm

Journal references: *AJO*, Vol. 119, No. 2, pp. 232-233, February 1995; *Eye Net*, Vol. 5, No. 4, pp. 33-34, April 2001; *Ophthalmic Surgery*, Vol. 15, No. 9, pp. 731-733, September 1984; *Ophthalmology*, Vol. 103, No. 2, pp. 306-314, February 1996; *Ophthalmology Times*, Vol. 16, No. 9, May 1991; *Ophthalmic Surgery & Lasers*, Vol. 31, No. 2, pp. 94-99, March/April 2000

## NEW OCULAR LAYDEN SUTURE LYSIS LENS

Designed for laser suture lysis after trabeculectomy or cataract surgery. The lens compresses the overlying conjunctival blood vessels and provides a clear view of the sutures. 1.6mm diameter tip simplifies locating and lasering sutures in patients with dark or highly pigmented sclera.

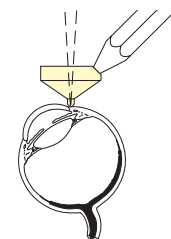

Product Code	Image Mag.	Laser Spot Mag.	Contact Diam.	Handle Length
OLSA	1.00x	1.00x	1.6mm	79mm

ALL LASER LENSES USE CLEANING METHOD 1 \* No methylcellulose required



### OCULAR MANDELKORN SUTURE LYSIS

Designed for laser suture lysis after trabeculectomy or cataract surgery. The lens compresses conjunctival blood vessels and provides a clear view of the sutures. Allows complete visualization of the surgical site.

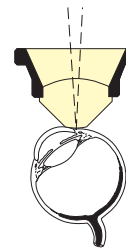

Product Code	Image Mag.	Laser Spot Mag.	Contact Diam.	Lens Height
OMSLA	1.32x	.76x	5.6mm	21mm

Journal references: *Eye Net*, Vol. 5, No. 4, pp. 33-34, April 2001; *Ocular Surgery News*, Vol. 13, No. 20, October 1995; *Ocular Surgery News Int'l*, Vol. 6, No. 10, p. 54, October 1995; *Ophthalmic Surgery*, Vol. 25, No.7, pp. 480-481, July 1994



### OCULAR RITCH NYLON SUTURE

Designed for laser suture lysis after trabeculectomy or cataract surgery. The lens compresses conjunctival blood vessels and provides a clear view of the sutures. Cone shaped lens with flange provides lid retraction.



Product Code	Image Mag.	Laser Spot Mag.	Contact Diam.	Lens Height
ORNSA	1.00x	1.00x	5.7mm	25.5mm

Journal references: *Eye Net*, Vol. 5, No. 4, pp. 33-34, April 2001  
*Ophthalmic Surgery*, Vol. 25, No. 2, pp. 126-127, February 1994



### OCULAR FUNDUS

This "Goldmann" type fundus lens provides clear visualization of the posterior pole. Using the NMR-K (Kapetansky) style contact surface design, direct examination and laser treatment of the posterior pole can be performed without methylcellulose.

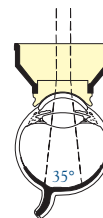

Product Code	Image Mag.	Laser Spot Mag.	Contact Diam.	Lens Height	Static FOV
OGFA	.93x	1.08x	15.5mm	16.5mm	36°
OGFA-2*	.97x	1.03x	15.5mm	16.5mm	35°

### OCULAR YANNUZZI FUNDUS

Designed for viewing and treatment of the posterior pole. Large scleral flange allows greater control of the globe.

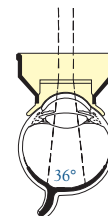

Product Code	Image Mag.	Laser Spot Mag.	Contact Diam.	Lens Height	Static FOV
OYFA	.93x	1.08x	20mm	16.5mm	36°

Journal reference: *AJO*, Vol. 101, No. 5, pp. 619-620, May 1986

Ocular Argon/Diode Lenses come with Laserlight® coating for maximum brightness and easy cleaning, see page 62.





## OCULAR ABRAHAM IRIDECTOMY



A 10mm diameter, 66D magnifying button in the anterior surface of the lens is positioned over the peripheral iris to give a clear view of the iridectomy site. Laser efficiency is increased compared with using no lens. The lens also helps stabilize the patient's eye and retains the eye lids.

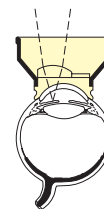

Product Code	Image Mag.	Laser Spot Mag.	Contact Diam.	Lens Height
OAIY	1.5x	.67x	15.5mm	16.5mm

Journal reference: *Ophthalmic Surgery & Lasers*, Vol. 27, No. 3, pp. 209-227, March 1996

## OCULAR ABRAHAM CAPSULOTOMY



Stabilizes the patient's eye and minimizes the possibility of pitting the IOL during Nd:YAG laser capsulotomy. A 10mm diameter, 66D magnifying button in the center of the lens enhances visualization and allows precise laser focus on the posterior capsule.

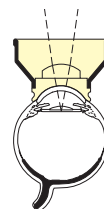

Product Code	Image Mag.	Laser Spot Mag.	Contact Diam.	Lens Height
OAYA	1.8x	.56x	15.5mm	16.5mm

Journal reference: *Ocular Surgery News*, Vol. 14, No. 17, p. 36, September 1, 1996

## OCULAR LATINA SLT GONIO LASER LENS



Designed specifically for Selective Laser Trabeculoplasty. 1.0x magnification maintains laser spot size for accurate laser energy delivery. Tilted anterior lens surface corrects astigmatism to maintain circular laser beam profile and give sharp images for examination. Suitable for Standard Laser Trabeculoplasty. Large 63° mirror yields bright image for angle photography. Available with the Ocular Securefit® flange for increased stability.

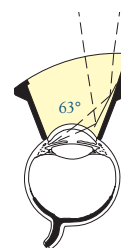

Product Code	Gonio Mag.	Gonio Laser Spot Mag.	Contact Diam.	Lens Height	Field of View
OLSLT	1.0x	1.0x	14.5mm	24mm	130°
OLSLTF (w/flange)	1.0x	1.0x	18mm	25mm	130°

ALL LASER LENSES USE CLEANING METHOD 1



**OCULAR PEYMAN G. CAPSULOTOMY**

Designed for posterior capsulotomy, this lens features a 14mm diameter anterior surface and a slightly greater working distance than the Abraham Lens.

Product Code	Image Mag.	Laser Spot Mag.	Contact Diam.	Lens Height
OPYG -12-12	1.8x	.56x	15.5mm	16.5mm

Journal reference: EyeNet, Vol. 5, No. 8, pp. 35-37, August 2001

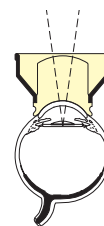

**OCULAR MANDELKORN IRIDOTOMY/CAPSULOTOMY**

Large anterior surface allows visualization of the iris and posterior capsule. Designed for Argon/Diode or Nd:YAG iridotomy, and YAG capsulotomy.

Product Code	Image Mag.	Laser Spot Mag.	Contact Diam.	Lens Height
OMIC	1.2x	.83x	15.5mm	16.5mm

Journal reference: Ocular Surgery News, Vol. 16, No. 9, p. 67, September 1998

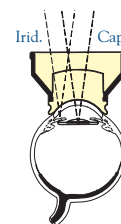

**OCULAR POLLACK IRIDOTOMY/GONIO**

The Pollack Iridotomy-Gonio Laser Lens has two coated glass buttons on the anterior surface that enable performance of iridotomy and gonioscopy without changing lenses and with minimal refocusing of the slit lamp. It is designed to easily determine if the angle has been opened following iridotomy. The 1.5x magnification button allows lower levels of energy to be employed during the procedure. Also suitable for Argon Laser Trabeculoplasty (ALT). Image mag is 1.5x for both iris and anterior chamber angle.

Product Code	Image Mag.	Laser Spot Mag.	Contact Diam.	Lens Height
OPIG	1.5x	.65x	15mm	21mm

U.S. Patent #6,698,886

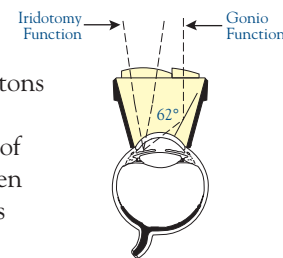

Ocular Argon/Diode Lenses come with Laserlight® coating for maximum brightness and easy cleaning, see page 62.





## OCULAR KARICKHOFF OFF-AXIS VITREOUS LENS

Lens very helpful in treating off-axis floaters. Rotating the lens allows looking for floaters without patient moving their eye. Focus is more posterior and allows monitoring of the retina during treatment in most patients. Black mark on lens indicates the direction of peripheral view. Anterior lens surface design reduces image astigmatism and image degradation when tilting the lens. Small flange prevents lens being squeezed off eye by patient.

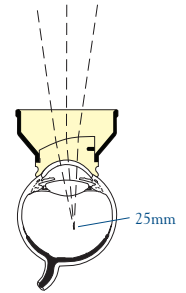

Product Code	Image Mag.	Laser Spot Mag.	Contact Diam.	Lens Height
OJKPY-25	1.36x	.74x	15.5mm	16.5mm

Journal reference: *Ocular Surgery News*, Vol. 25, No. 6, pp 51-54, March 15, 2007



## OCULAR KARICKHOFF 21MM VITREOUS LENS

Most useful lens for laser treatment of vitreous floaters. Small flange helps prevent lens being squeezed off eye by patient. Small exterior diameter enables lens to be inserted into an eye with small lid fissures. Lens allows surgeon to view retina clearly in most patients during procedure to check for hemorrhage. Serrated holding ring for easy grip.

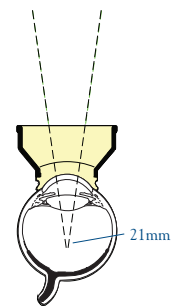

Product Code	Image Mag.	Laser Spot Mag.	Contact Diam.	Lens Height
OJKY-21	1.39x	.72x	15.5mm	16mm

Journal reference: *Ocular Surgery News*, Vol. 25, No. 6, pp 51-54, March 15, 2007



## OCULAR PEYMAN WIDE FIELD

Three lenses designed for YAG laser treatment in the vitreous. 12.5mm for anterior vitreous, 18mm for mid-vitreous, 25mm for posterior vitreous. The convex anterior surface of each lens optimizes image magnification and laser performance in the area of interest.

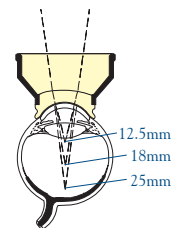

Product Code	Image Mag.	Laser Spot Mag.	Contact Diam.	Lens Height
OPY-12.5	1.40x	.71x	15.5mm	16.5mm
OPY-18	1.41x	.71x	15.5mm	16.5mm
OPY-25	1.36x	.74x	16mm	14.7mm

Journal reference: *Retina*, Vol. 4, No. 2, pp. 129-131, February 1984

ALL LASER LENSES USE CLEANING METHOD 1

# DIAGNOSTIC LENSES

Ocular Instruments offers many lens styles that cater to your personal preference. Now our popular Posner and Sussman Four Mirror Gonio Lenses are available with red, blue, green, gold, purple, or traditional black handles and rings.





## OCULAR THREE MIRROR UNIVERSAL

This classic "Goldmann" type lens has three mirrors angled at 59°, 67° and 73° to permit viewing of the peripheral fundus and anterior chamber angle. 36° of the posterior pole can be viewed through the center of the lens. Many heights and diameters are available. Gonio mag .80x. Also available with our high performance, anti-reflective coating. See page 8 for more details.

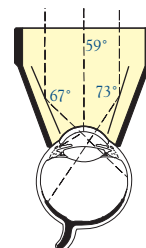

Product Code	Style	Image Mag.	Contact Diam.	Lens Height	Static Gonio FOV
OG3M	Universal	.93x	18mm	32mm	140°
OG3M-2*	NMR	.93x	16mm	32mm	140°
OG3MF	with flange	.93x	20mm	33mm	140°
OG3MI	15mm	.93x	15mm	28mm	140°
OG3MP	17mm	.93x	17mm	26mm	140°
OG3MS	Short	.93x	18mm	24mm	140°
OG3MS-2*	NMR Short	.93x	16mm	23mm	140°
OG3M-13*	NMR Small Fissure	.93x	13mm	28mm	140°

Journal reference: *The Journal of Ophthalmic Photography*, Vol. 26, No. 1, pp. 13-19, Spring 2004



## OCULAR KARICKHOFF DIAGNOSTIC

Four mirrors plus a central axis view give a complete view of the interior of the eye. Unique "depth dots" mark each mirror at the base for easy orientation. One dot, 62° (anterior chamber angle); two dots, 67° (ora serrata); three dots, 76° (mid-equator); four dots, 80° (mid-peripheral area). The mirrors provide fields of view that overlap completely. Gonio mag .80x. Also available with our high performance, anti-reflective coating. See page 9 for more details.

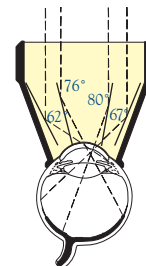

Product Code	Image Mag.	Contact Diam.	Lens Height	Static Gonio FOV
OJK	.93x	18mm	29mm	140°
OJKF (w/flange)	.93x	20mm	30mm	140°

DIAGNOSTIC LENSES USE CLEANING METHOD 1 UNLESS OTHERWISE NOTED

\* No methylcellulose required



### OCULAR HIGH DEFINITION THREE MIRROR

Provides mirrors for examination of the fundus and the anterior chamber angle. High index glass three mirror lens with our Laserlight® HD anti-reflective coating for maximum light transmission and image brightness. One 64° gonio mirror and two fundus mirrors, 73° and 67°. Fundus images overlap, no “blind spot” in fundus field. Outstanding for laser and diagnostic applications – 15mm or 17mm flange adapters recommended for laser procedures. Compatible with visible and near infrared lasers. Methylcellulose not required.

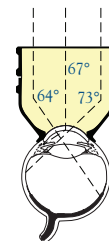

Product Code	Image Mag.	Laser Spot Mag.	Contact Diam.	Lens Height	Static Gonio FOV
OG3MHD-10*	.65x	1.54x	10mm	25.0mm	150°
OG3MHD-15*	.65x	1.54x	15mm	26.5mm	150°
(OG3MHD-10 Lens w/OACF-15 flange)					
OG3MHD-17	.65x	1.54x	17mm	27.5mm	150°
(OG3MHD-10 Lens w/OACF-17 flange; methylcellulose recommended)					

Flanges also sold separately, see accessory section.  
U.S. Patent #6,767,098



### OCULAR AUTOCLAVABLE THREE MIRROR

Provides mirrors for the examination of the fundus and the anterior chamber angle. **Steam sterilizable** universal ophthalmic lens prism. High index glass design. Mirrors maintain total internal reflection as if they are coated. One 64° gonio mirror and two fundus mirrors, 73° and 67°. Fundus images overlap, no “blind spot” in fundus field. Methylcellulose not required. Cleaning Method 3. Gonio mag .61x.

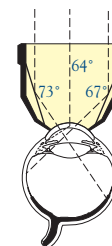

Product Code	Image Mag.	Contact Diam.	Lens Height	Static Gonio FOV
OG3MAC-10*	.60x	10mm	25mm	150°
OG3MAC-15*	.60x	15mm	26.5mm	150°
(OG3MAC-10 Lens w/OACF-15 flange)				
OG3MAC-17	.60x	17mm	27.5mm	150°
(OG3MAC-10 Lens w/OACF-17 flange; methylcellulose recommended)				

Flanges also sold separately, see accessory section.  
U.S. Patent #6,767,098



### OCULAR THREE MIRROR 10MM GONIO

Three mirrors of 64°, 67° and 73° and a small diameter contact surface for use without methylcellulose. The fundus can be viewed through the central axis of the lens. Multi-layer polymer coating protects mirrors and is compatible with most disinfecting methods. Gonio mag .80x.

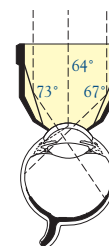

Product Code	Image Mag.	Contact Diam.	Lens Height	Static Gonio FOV
OG3M-10*	.93x	10mm	25mm	140°

Ocular Argon/Diode Lenses come with Laserlight® coating for maximum brightness and easy cleaning, see page 62.



## OCULAR MAGNA VIEW GONIO

The Ocular Magna View Gonio Lens is an outstanding choice for gonioscopy and digital photography of the anterior chamber angle. Three different lens styles are available to suit your needs including the Single Mirror, Two Mirror, and a higher magnification 1.5X. All three styles are also available with the Ocular Securefit® flange. See page 10 for more details.



## OCULAR SINGLE MIRROR GONIO

Small size gonio lens with one 62° mirror. Compact knurled ring simplifies 360° viewing of the anterior chamber angle. Methylcellulose and NMR-K (Kapetansky) no methylcellulose designs available. Available with the Ocular Securefit® flange. Also available with our high performance, anti-reflective coating. See page 11 for more details.

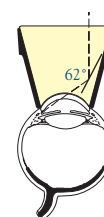

Product Code	Gonio Mag.	Contact Diam.	Lens Height	Static Gonio FOV
OSMG	.80x	15mm	19.5mm	170°
OSMG-2*	.80x	15mm	19.5mm	170°
OSMGF (w/flange)	.80x	17mm	20.5mm	170°



## OCULAR TWO MIRROR GONIO

Two opposing 62° mirrors provide a complete view of the anterior chamber angle with only a 180° lens rotation. Methylcellulose and NMR-K (Kapetansky) no methylcellulose designs available. Available with the Ocular Securefit® flange. Also available with our high performance, anti-reflective coating. See page 11 for more details.

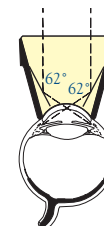

Product Code	Gonio Mag.	Contact Diam.	Lens Height	Static Gonio FOV
O2M	.80x	15mm	19.5mm	170°
O2M-2*	.80x	15mm	19.5mm	170°
O2MF (w/flange)	.80x	17mm	20.5mm	170°



## OCULAR FOUR MIRROR MINI GONIO

Four 62° mirrors allow complete observation of the angle with little lens rotation. Small diameter flange is convenient for eyes with small palpebral fissures. Anterior holding ring available in small and large sizes. Methylcellulose not required for most patients. Also available with our high performance, anti-reflective coating. See page 11 for more details.

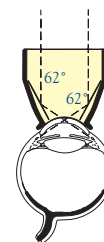

Product Code	Gonio Mag.	Contact Diam.	Lens Height	Ring Diam.	Static Gonio FOV
O4GF*	.80x	15mm	22.5mm	23.5mm	120°
O4GF-LR*	.80x	15mm	26mm	32.5mm	120°

DIAGNOSTIC LENSES USE CLEANING METHOD 1 UNLESS OTHERWISE NOTED

\* No methylcellulose required



**NEW OCULAR KHAW 4D DIRECT VIEW GONIO**

Traditional and 1X magnification versions available. The Khaw 4D Direct View Gonio Lenses combine the most favorable features of traditional gonioprisms while providing a properly orientated view of the angle. 360° of anterior chamber angle is visible with little to no lens rotation. Anterior chamber charting made easier with correct image orientation. No methylcellulose required lens design.

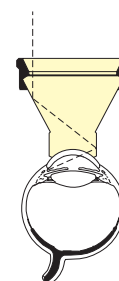

Product Code	Gonio Mag.	Contact Diam.	Lens Height	Ring Diam.	Static Gonio FOV
OK4DG*	.80x	10mm	24mm	28.5mm	170°
OK4DG-1X*	1.05x	10mm	23mm	28.5mm	150°

US Patent #6,976,758. Euro Patent #1 464 271



**NEW OCULAR GAASTERLAND FOUR MIRROR GONIO**

Traditional and 1X magnification versions available. New Laserlight® HD anti-reflective coating on anterior surface for maximum image brightness and contrast. High Refractive Index glass provides total internal reflection even with fluid in contact with the mirrors. Larger field means no need to rotate lens to see entire anterior chamber angle. Choice of large or small holding ring. Also available with ergonomic handle. Lens is easily detached from handle for cleaning. Outstanding for laser and diagnostic applications – 15mm and 17mm flange adapters recommended for laser procedures. Compatible with visible and near infrared lasers. Methylcellulose not required.

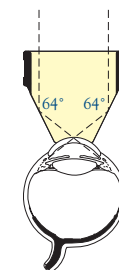

Product Code	Gonio Mag.	Gonio Laser Spot Mag	Contact Diam.	Lens Height	Ring Diam.	Static FOV
OG4MG*	.61x	1.64x	8.5mm	22mm	24.5mm	90°+
OG4MG-15*	.61x	1.64x	15mm	24.5mm	24.5mm	90°+
(OG4MG lens w/OACF4-15 flange)						
OG4MG-17	.61x	1.64x	17mm	25.5mm	24.5mm	90°+
(OG4MG lens w/OACF4-17 flange; methylcellulose recommended)						
OG4MG-1R*	.61x	1.64x	8.5mm	28mm	31.5mm	90°+
OG4MG-1R-15*	.61x	1.64x	15mm	30mm	31.5mm	90°+
(OG4MG-1R lens w/OACF4-15 flange)						
OG4MG-1R-17	.61x	1.64x	17mm	31mm	31.5mm	90°+
(OG4MG-1R lens w/OACF4-17 flange; methylcellulose recommended)						
OG4MGH*	.61x	1.64x	8.5mm	18mm	n/a	90°+
OG4MG-1X*	1.0x	1.0x	8.5mm	22mm	24.5mm	90°+
OG4MG-1X-15*	1.0x	1.0x	15mm	24.5mm	24.5mm	90°+
(OG4MG-1X lens w/OACF4-15 flange)						
OG4MG-1X-17	1.0x	1.0x	17mm	25.5mm	24.5mm	90°+
(OG4MG-1X lens w/OACF4-17 flange; methylcellulose recommended)						
OG4MG-1X-1R*	1.0x	1.0x	8.5mm	28mm	31.5mm	90°+
OG4MG-1X-1R-15*	1.0x	1.0x	15mm	30mm	31.5mm	90°+
(OG4MG-1X-1R lens w/OACF4-15 flange)						
OG4MG-1X-1R-17	1.0x	1.0x	17mm	31mm	31.5mm	90°+
(OG4MG-1X-1R lens w/OACF4-17 flange; methylcellulose recommended)						
OG4MG-1X-H*	1.0x	1.0x	8.5mm	18mm	n/a	90°+

Flanges also sold separately, see accessory section. U.S. Patent #6,767,098

Ocular Argon/Diode Lenses come with Laserlight® coating for maximum brightness and easy cleaning, see page 62.

## NEW OCULAR MAXFIELD® AC FOUR MIRROR GONIO

Traditional and 1X magnification versions available. High Refractive Index glass provides total internal reflection even with fluid in contact with the mirrors. Total internal reflection means no light absorption or loss by a mirror coating resulting in a brighter, clearer image. High resolution image of the anterior chamber angle. **Steam sterilizable.** Available with small or large holding ring. Also available with ergonomic handle. Lens is easily detached from handle for cleaning and sterilization. Cleaning Method 3. Gonioscopic solution is not required to provide optical interface. Purchase with or separately a 15mm or 17mm lens flange to eliminate the need to purchase additional lenses with dedicated flanges. Flange cover is easily removed from the lens for cleaning and sterilization.

Product Code	Gonio Mag.	Contact Diam.	Lens Height	Ring Diam.	Static FOV
O4MAC*	.61x	8.5mm	22mm	24.5mm	90°+
O4MAC-15*	.61x	15mm	24.5mm	24.5mm	90°+ (O4MAC lens w/OACF4-15 flange)
O4MAC-17	.61x	17mm	25.5mm	24.5mm	90°+ (O4MAC lens w/OACF4-17 flange; methylcellulose recommended)
O4MAC-LR*	.61x	8.5mm	28mm	31.5mm	90°+
O4MAC-LR-15*	.61x	15mm	30mm	31.5mm	90°+ (O4MAC-LR lens w/OACF4-15 flange)
O4MAC-LR-17	.61x	17mm	31mm	31.5mm	90°+ (O4MAC-LR lens w/OACF4-17 flange; methylcellulose recommended)
O4MACH*	.61x	8.5mm	18mm	n/a	90°+
O4MAC-1X*	1.0x	8.5mm	22mm	24.5mm	90°+
O4MAC-1X-15*	1.0x	15mm	24.5mm	24.5mm	90°+ (O4MAC-1X lens w/OACF4-15 flange)
O4MAC-1X-17	1.0x	17mm	25.5mm	24.5mm	90°+ (O4MAC-1X lens w/OACF4-17 flange; methylcellulose recommended)
O4MAC-1X-LR*	1.0x	8.5mm	28mm	31.5mm	90°+
O4MAC-1X-LR-15*	1.0x	15mm	30mm	31.5mm	90°+ (O4MAC-1X-LR lens w/OACF4-15 flange)
O4MAC-1X-LR-17	1.0x	17mm	31mm	31.5mm	90°+ (O4MAC-1X-LR lens w/OACF4-17 flange; methylcellulose recommended)
O4MAC-1X-H*	1.0x	8.5mm	18mm	n/a	90°+

Flanges also sold separately, see accessory section. U.S Patent #6,767,098

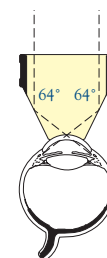

## OCULAR FUNDUS DIAGNOSTIC

The flat front surface of this “Goldmann” type fundus lens provides a direct image of the posterior pole. Methylcellulose and NMR-K (Kapetansky) no methylcellulose designs available. Also available with our high performance, anti-reflective coating. See page 13 for more details.

Product Code	Image Mag.	Contact Diam.	Lens Height	Static FOV
OGF	.93x	15.5mm	16.5mm	36°
OGF-2*	.97x	15.5mm	16.5mm	35°

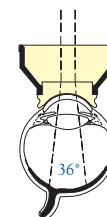

DIAGNOSTIC LENSES USE CLEANING METHOD 1 UNLESS OTHERWISE NOTED

\* No methylcellulose required





### OCULAR POSNER DIAGNOSTIC AND SURGICAL GONIOPRISM

New handle design for strength and durability. Four 64° mirrors for complete anterior chamber angle viewing with minimal lens rotation. Choice of three handles set at 17° for ease of use. Small diameter contact surface allows static or dynamic gonioscopy without methylcellulose. Advanced technology, multi-layer polymer coating protects mirrors and is compatible with most disinfecting methods. Available with red, blue, green, gold, purple, or traditional black handle.

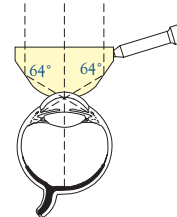

Product Code	Handle Style	Gonio Mag.	Contact Diam.	Lens Height	Handle Length	Static Gonio FOV
OPDSG*	Round	.80x	9mm	13mm	79mm	80°
OPDSG-2*	Hexagonal	.80x	9mm	13mm	72mm	80°
OPDSG-3*	Ergonomic	.80x	9mm	13mm	93mm	80°

Journal references: *Ophthalmology Times*, Vol. 4, No. 6, p. 8, June 1979  
*Optometric Management*, Vol. 35, No. 6, June 2000



### OCULAR SUSSMAN FOUR MIRROR HAND HELD GONIOSCOPE

Four 64° mirrors for complete anterior chamber angle viewing with minimal lens rotation. Directly hand held for easy handling and stability. Choice of large or small holding ring. Small diameter contact surface allows static or dynamic gonioscopy without methylcellulose. Advanced technology, multi-layer polymer coating protects mirrors and is compatible with most disinfecting methods. Available with red, blue, green, gold, purple, or traditional black holding ring.



Product Code	Gonio Mag.	Contact Diam.	Lens Height	Ring Diam.	Static Gonio FOV
OS4M*	.80x	9mm	24.5mm	25mm	80°
OS4M-2*	.80x	9mm	28.5mm	31.5mm	80°

Journal reference: *Optometric Management*, Vol. 35, No. 6, June 2000.

### OCULAR THORPE FOUR MIRROR GONIO

Four 62° mirrors give a 360° view of the anterior chamber angle with only a slight lens rotation. Posterior pole can be viewed through center of lens. Image mag .93x. Also available with our high performance anti-reflective coating. See page 12 for more details.

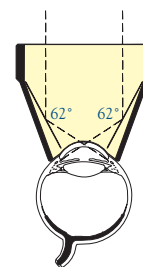

Product Code	Gonio Mag.	Contact Diam.	Lens Height	Static Gonio FOV
OT4MG	.80x	18mm	32mm	150°

### OCULAR KOEPPE DIAGNOSTIC

Direct gonioscopy lens with magnification. The lens rests on the scleral flange creating a corneal vault and leaving the anterior chamber angle undisturbed. Three sizes available.

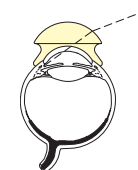

Product Code	Style	Image Mag.	Contact Diam.	Static Gonio FOV
OKL	Large	1.50x	19mm	160°
OKM	Medium	1.53x	18mm	160°
OKS	Small	1.57x	17mm	160°

Ocular Argon/Diode Lenses come with Laserlight® coating for maximum brightness and easy cleaning, see page 62.



NEW Laserlight® HD coating now available on our MaxField® Indirect product line. Brighter images. Less reflection. Great for digital imaging! See coatings and materials (page 62) for more details.



Add some extra style to your everyday tools. All of our Maxlight® and MaxField® Indirect Lenses are now available with red, blue, green, gold, purple, or traditional black holding rings, with the exception of the Ocular Ultra View Small Pupil (OI-SP).



**INDIRECT DIAGNOSTIC/LASER LENS COMPARISON CHART**

PRODUCT CODE & DESCRIPTION	USAGE	IMAGE MAG (approx)	LASER SPOT MAG FACTOR	STATIC FOV	DYNAMIC FOV (mm)	WORKING DISTANCE (mm)	CLEAR APERTURE (mm)	LENS WEIGHT (grams)	ASPHERE MATERIAL
OI-14 MaxLight® 14D	BIO	4.29x	.23x	37°	NA	72.0	52.0	34	CR-39
OI-14M HD MaxField® 14D	BIO	4.17x	.24x	38°	NA	72.0	52.0	57	GLASS
OI-18 MaxLight® 18D	BIO	3.40x	.29x	44°	NA	55.0	48.0	39	CR-39
OI-18M HD MaxField® 18D	BIO	3.40x	.29x	44°	NA	55.0	48.0	58	GLASS
OI-20 MaxLight® 20D	BIO	2.97x	.34x	50°	NA	47.0	48.0	39	CR-39
OI-20A MaxAC® Autoclavable 20D	BIO/O.R.	3.03x	.33x	50°	NA	47.0	48.0	51	GLASS
OI-20M HD MaxField® 20D	BIO	2.97x	.34x	50°	NA	47.0	48.0	56	GLASS
OI-222 MaxLight® Triple Two 22D	BIO	2.72x	.37x	60°	NA	39.0	52.0	48	CR-39
OI-22M HD MaxField® 22D	BIO	2.73x	.37x	60°	NA	39.0	52.0	73	GLASS
OI-25M HD MaxField® 25D	BIO	2.40x	.42x	63°	NA	33.0	48.0	59	GLASS
OI-28 MaxLight® 28D	BIO	2.13x	.47x	58°	NA	29.0	38.0	22	CR-39
OI-28A MaxAC® Autoclavable 28D	BIO/O.R.	2.15x	.47x	59°	NA	28.0	38.0	36	GLASS
OI-28M HD MaxField® 28D	BIO	2.11x	.47x	58°	NA	27.0	38.0	39	GLASS
OI-30M HD MaxField® 30D	BIO	1.97x	.51x	63°	NA	26.0	38.0	38	GLASS
OI-35M HD MaxField® 35D	BIO	1.71x	.58x	74°	NA	17.0	34.0	32	GLASS
OI-40M HD MaxField® 40D	BIO	1.49x	.67x	82°	NA	14.0	34.0	32	GLASS
OI-54M HD MaxField® 54D	SLIT LAMP	1.10x	.90x	86°	137°	10.0	29.0	25	GLASS
OI-UM MaxLight® Ultra Mag 60	SLIT LAMP	1.15x	.87x	76°	131°	11.0	30.0	17	CR-39
OI-60M HD MaxField® 60D	SLIT LAMP	1.00x	1.00x	85°	154°	10.0	29.0	32	GLASS
OI-66M HD MaxField® 66D	SLIT LAMP	.91x	1.10x	91°	144°	8.0	27.0	25	GLASS
OI-72M HD MaxField® 72D	SLIT LAMP	.83x	1.20x	102°	155°	7.0	27.0	21	GLASS
OI-HM MaxLight® High Mag 78D	SLIT LAMP	.93x	1.07x	84°	139°	8.0	29.0	17	CR-39
OI-HM-78M HD MaxField® High Mag 78D	SLIT LAMP	.98x	1.02x	88°	154°	10.0	29.0	32	GLASS
OI-78M Osher MaxField® 78D HD	SLIT LAMP & SURGICAL SCOPE	.77x	1.30x	98°	155°	7.0	27.0	21	GLASS
OI-84M HD MaxField® 84D	SLIT LAMP	.71x	1.40x	105°	158°	5.0	27.0	28	GLASS
OI-STD MaxLight® Standard 90	SLIT LAMP	.75x	1.34x	94°	153°	5.0	19.0	6	CR-39
OI-STD M HD MaxField® Standard 90	SLIT LAMP	.75x	1.34x	94°	153°	5.0	19.0	9	GLASS
OI-STD-LR MaxLight® Std 90 w/Lg Ring	SLIT LAMP	.75x	1.34x	94°	153°	5.0	19.0	15	CR-39
OI-STD M-LR HD MaxField® Std 90 w/Lg Ring	SLIT LAMP	.75x	1.34x	94°	153°	5.0	19.0	18	GLASS
OI-100M HD MaxField® 100D	SLIT LAMP	.60x	1.67x	110°	146°	4.0	21.0	18	GLASS
OI-120M HD MaxField® 120D	SLIT LAMP	.50x	2.00x	120°	173°	4.0	21.0	19	GLASS
OI-SP HD Ultra View SP 132D	SLIT LAMP	.45x	2.22x	99°	158°	4.0	16.0	9	GLASS

COATING: Laserlight® and Laserlight® HD anti-reflective coating, for maximum brightness and easy cleaning, see page 62

**BINOCULAR INDIRECT OPHTHALMOSCOPY (BIO) LENSES**

**MAXLIGHT® CR-39 ASPHERIC LENSES**



**OCULAR MAXLIGHT® 14 DIOPTER**

High magnification for detailed examination of macula and optic disc. Available with red, blue, green, gold, purple, or traditional black holding ring.

Product Code	Image Mag.	Laser Spot Mag.	Static FOV	Working Distance	Clear Aperture	Lens Weight
OI-14	4.29x	.23x	37°	72mm	52mm	34g



**NEW Ocular Maxlight® 18 Diopter**

High resolution image with 15% more magnification than a 20D for greater detail. Available with red, blue, green, gold, purple, or traditional black holding ring.

Product Code	Image Mag.	Laser Spot Mag.	Static FOV	Working Distance	Clear Aperture	Lens Weight
OI-18	3.40x	.29x	44°	55mm	48mm	39g



**OCULAR MAXLIGHT® 20 DIOPTER**

Most common lens for B.I.O. High resolution image. Available with red, blue, green, gold, purple, or traditional black holding ring.

Product Code	Image Mag.	Laser Spot Mag.	Static FOV	Working Distance	Clear Aperture	Lens Weight
OI-20	2.97x	.34x	50°	47mm	48mm	39g



**OCULAR MAXLIGHT® TRIPLE TWO PANFUNDUS**

Bigger aperture and field of view than a 20D. 22D lens for general fundus exam with the binocular indirect ophthalmoscope. Large diameter and unique optical design combine magnification with very wide field of view. Available with red, blue, green, gold, purple, or traditional black holding ring.

Product Code	Image Mag.	Laser Spot Mag.	Static FOV	Working Distance	Clear Aperture	Lens Weight
OI-222	2.72x	.37x	60°	39mm	52mm	48g

INDIRECT LENSES USE CLEANING METHOD 2  
 MaxAC® AUTOCLAVABLE LENSES USE METHOD 3



### OCULAR MAXLIGHT® 28 DIOPTER

Excellent lens for use during **pediatric examinations**. Excellent general purpose lens. Small diameter, easy to handle. Popular for examining children. Available with red, blue, green, gold, purple, or traditional black holding ring.

Product Code	Image Mag.	Laser Spot Mag.	Static FOV	Working Distance	Clear Aperture	Lens Weight
OI-28	2.13x	.47x	58°	29mm	38mm	22g

## MAXFIELD® GLASS ASPHERIC LENSES

**NEW Laserlight® HD** anti-reflective coating now available on our MaxField® Indirect product line. Brighter images. Less reflection.



### OCULAR MAXFIELD® 14D

**High magnification** for high detail. Features a computer optimized aspheric design for maximum resolution and field of view. Made of high transmittance glass for bright, clear images. Available with red, blue, green, gold, purple, or traditional black holding ring. Now available with our **NEW Laserlight® HD** anti-reflective coating. See Coatings and Materials (page 62) for details.

Product Code	Image Mag.	Laser Spot Mag.	Static FOV	Working Distance	Clear Aperture	Lens Weight
OI-14M	4.17x	.24x	38°	72mm	52mm	57g

### **NEW** OCULAR MAXFIELD® 18D



High resolution image with **15% more magnification than a 20D** for greater detail. Available with red, blue, green, gold, purple, or traditional black holding ring. Now available with our **NEW Laserlight® HD** anti-reflective coating. See Coatings and Materials (page 62) for details.

Product Code	Image Mag.	Laser Spot Mag.	Static FOV	Working Distance	Clear Aperture	Lens Weight
OI-18M	3.40x	.29x	44°	55mm	48mm	58g

### OCULAR MAXFIELD® 20D

**Most common** lens for B.I.O. High resolution image. Available with red, blue, green, gold, purple, or traditional black holding ring. Now available with our **NEW Laserlight® HD** anti-reflective coating. See Coatings and Materials (page 62) for details.



Product Code	Image Mag.	Laser Spot Mag.	Static FOV	Working Distance	Clear Aperture	Lens Weight
OI-20M	2.97x	.34x	50°	47mm	48mm	56g

Ocular Indirect Lenses come with Laserlight® coating for maximum brightness and easy cleaning, see page 62.

MaxAC® autoclavable lenses are uncoated for sterilization compatibility.



## OCULAR MAXFIELD® 22D

**Bigger aperture and field of view than a 20D.** Features a computer optimized aspheric design for maximum resolution and field of view. Available with red, blue, green, gold, purple, or traditional black holding ring. Now available with our NEW Laserlight® HD anti-reflective coating. See Coatings and Materials (page 62) for more details.

Product Code	Image Mag.	Laser Spot Mag.	Static FOV	Working Distance	Clear Aperture	Lens Weight
OI-22M	2.73x	.37x	60°	39mm	52mm	73g

## NEW OCULAR MAXFIELD® 25D



**Ideal for examination of ROP patients.** Excellent lens for use during pediatric examinations. More field of view than a 20D. Features a computer optimized aspheric design for maximum resolution and field of view. Available with red, blue, green, gold, purple, or traditional black holding ring. Now available with our NEW Laserlight® HD anti-reflective coating. See Coatings and Materials (page 62) for details.

Product Code	Image Mag.	Laser Spot Mag.	Static FOV	Working Distance	Clear Aperture	Lens Weight
OI-25M	2.40x	.42x	63°	33mm	48mm	59g

## OCULAR MAXFIELD® 28D



Excellent lens for use during **pediatric examinations**. Excellent general purpose lens. Small diameter easy to handle. Popular for examining children. Available with red, blue, green, gold, purple, or traditional black holding ring. Now available with our NEW Laserlight® HD anti-reflective coating. See Coatings and Materials (page 62) for details.

Product Code	Image Mag.	Laser Spot Mag.	Static FOV	Working Distance	Clear Aperture	Lens Weight
OI-28M	2.11x	.47x	58°	27mm	38mm	39g

## NEW OCULAR MAXFIELD® 30D



**10% more field than a 28D.** Features a computer optimized aspheric design for maximum resolution and field of view. Available with red, blue, green, gold, purple, or traditional black holding ring. Now available with our NEW Laserlight® HD anti-reflective coating. See Coatings and Materials (page 62) for details.

Product Code	Image Mag.	Laser Spot Mag.	Static FOV	Working Distance	Clear Aperture	Lens Weight
OI-30M	1.97x	.51x	63°	26mm	38mm	38g

INDIRECT LENSES USE CLEANING METHOD 2  
 MaxAC® AUTOCLAVABLE LENSES USE METHOD 3



### NEW OCULAR MAXFIELD® 35D

Works well through small pupils. Features a computer optimized aspheric design for maximum resolution and field of view. Available with red, blue, green, gold, purple, or traditional black holding ring. Now available with our NEW Laserlight® HD anti-reflective coating. See Coatings and Materials (page 62) for details.

Product Code	Image Mag.	Laser Spot Mag.	Static FOV	Working Distance	Clear Aperture	Lens Weight
OH35M	1.71x	.58x	74°	17mm	34mm	32g



### NEW OCULAR MAXFIELD® 40D

Quick scanning lens that works well through small pupils. For use during pediatric examinations. Features a computer optimized aspheric design for maximum resolution and field of view. Available with red, blue, green, gold, purple, or traditional black holding ring. Now available with our NEW Laserlight® HD anti-reflective coating. See Coatings and Materials (page 62) for details.

Product Code	Image Mag.	Laser Spot Mag.	Static FOV	Working Distance	Clear Aperture	Lens Weight
OH40M	1.49x	.67x	82°	14mm	34mm	32g



### NEW OCULAR LANDERS ROP LENS ATTACHMENT

Engraved bezel and crosshairs allow clock hour estimation in neo-vascularization when viewing ROP. Estimate the size of inflammatory/non-inflammatory retinal lesions. Grid spacing aids in estimating the size of ocular tumors. Bezel is conveniently marked at hour and half hour locations. Designed to fit anterior side of Ocular 28D Indirect Lenses\*. The Ocular 28D Indirect Lenses are sold separately.

Product Code  
OH.ROP

\*Lens design with diamond knurl pattern only

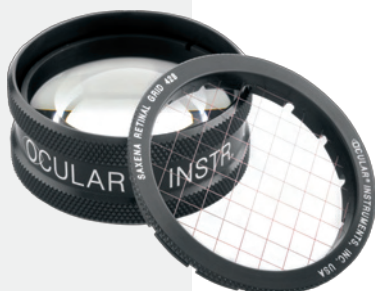

### NEW OCULAR SAXENA RETINAL GRID 428

Monofilament line at 4.0mm spacing provides reference to the size of the optic disc. Estimate the size of inflammatory/non-inflammatory retinal lesions. Grid spacing aids in estimating the size of ocular tumors. Easily estimates the amount of disk edema. Ideal for ROP. Designed to fit anterior side of Ocular 28D Indirect Lenses.\* The Ocular 28D Indirect Lenses are sold separately.

Product Code  
OI-SRG428

\*Lens design with diamond knurl pattern only

Ocular Indirect Lenses come with Laserlight® coating for maximum brightness and easy cleaning, see page 62.

MaxAC® autoclavable lenses are uncoated for sterilization compatibility.



## OCULAR SAXENA RETINAL GRID 520

Monofilament line at 5.20mm spacing provides reference to the size of the optic disc. Estimate the size of inflammatory/non-inflammatory retinal lesions. Grid spacing aids in estimating the size of ocular tumors. Easily estimate the amount of disk edema. Easily fits onto anterior side of Ocular 20D Indirect lenses\*. The Ocular 20D Indirect Lenses are sold separately.

Product Code

OI-SRG520

\* Lens design with diamond knurl pattern only

## MAXAC® INDIRECT LENSES



### OCULAR MAXAC® 20 DIOPTER

Provides ultra high resolution retinal image with the B.I.O. during clinical practice or in the operating room. Features computer optimized aspheric design for maximum resolution and field of view. **STEAM AUTOCLAVABLE.**

Lens not sold in autoclavable case. To order an autoclavable case order the OI-ST.

Product Code	Image Mag.	Laser Spot Mag.	Static FOV	Working Distance	Clear Aperture	Lens Weight
OI-20A	3.03x	.33x	50°	47mm	48mm	51g



### OCULAR MAXAC® 28 DIOPTER

Provides ultra high resolution retinal image with the B.I.O. during clinical practice or in the operating room. Features computer optimized aspheric design for maximum resolution and field of view. Small diameter, easy to handle.

**STEAM AUTOCLAVABLE.** Lens not sold in autoclavable case. To order an autoclavable case order the OI-ST.

Product Code	Image Mag.	Laser Spot Mag.	Static FOV	Working Distance	Clear Aperture	Lens Weight
OI-28A	2.15x	.47x	59°	28mm	38mm	36g

INDIRECT LENSES USE CLEANING METHOD 2  
 MaxAC® AUTOCLAVABLE LENSES USE METHOD 3



### OCULAR MAXAC® (AUTOCLAVABLE) LENS STAND

The lens stand minimizes water spots from the autoclave. Use during sterilization to hold the lens on edge.

[Product Code](#)

OHLA

## SLIT LAMP INDIRECT OPHTHALMOSCOPY LENSES

### MAXLIGHT® CR-39 ASPHERIC LENSES



#### OCULAR MAXLIGHT® ULTRA MAG 60

Designed for **detailed examination** of the macula and optic disc. Precision computer aided design and manufacturing yield high resolution. Available with red, blue, green, gold, purple, or traditional black holding ring.

Product Code	Image Mag.	Laser Spot Mag.	Static FOV	Dynamic FOV	Working Distance	Clear Aperture	Lens Weight
OHUM	1.15x	.87x	76°	131°	11mm	30mm	17g



#### OCULAR MAXLIGHT® HIGH MAG 78

**Unique combination of magnification and field.** High resolution to examine fine detail. Available with red, blue, green, gold, purple, or traditional black holding ring.

Product Code	Image Mag.	Laser Spot Mag.	Static FOV	Dynamic FOV	Working Distance	Clear Aperture	Lens Weight
OHM	.93x	1.07x	84°	139°	8mm	29mm	17g

Ocular Indirect Lenses come with Laserlight® coating for maximum brightness and easy cleaning, see page 62.

MaxAC® autoclavable lenses are uncoated for sterilization compatibility.





## OCULAR MAXLIGHT® STANDARD 90

The **most popular** power for non-contact fundus examination. Large and small holding ring available. Available with red, blue, green, gold, purple, or traditional black holding ring.

Product Code	Image Mag.	Laser Spot Mag.	Static FOV	Dynamic FOV	Working Distance	Clear Aperture	Lens Weight
OI-STD	.75x	1.34x	94°	153°	5mm	19mm	6g
OI-STD-LR	.75x	1.34x	94°	153°	5mm	19mm	15g

## MAXFIELD® GLASS ASPHERIC LENSES

**NEW Laserlight® HD** anti-reflective coating now available on our MaxField® Indirect product line. **Brighter images. Less reflection.**



## OCULAR MAXFIELD® 54D

**High magnification** and resolution for examining macula and disc. Excellent for high resolution **digital** imaging. Available with red, blue, green, gold, purple, or traditional black holding ring. Now available with our **NEW Laserlight® HD** anti-reflective coating. See Coatings and Materials (page 62) for more details.

Product Code	Image Mag.	Laser Spot Mag.	Static FOV	Dynamic FOV	Working Distance	Clear Aperture	Lens Weight
OI-54M	1.10x	.90x	86°	137°	10mm	29mm	25g



## OCULAR MAXFIELD® 60D

High resolution lens produces **one to one image** of fundus. Excellent for high resolution **digital** imaging. Available with red, blue, green, gold, purple, or traditional black holding ring. Now available with our **NEW Laserlight® HD** anti-reflective coating. See Coatings and Materials (page 62) for more details.

Product Code	Image Mag.	Laser Spot Mag.	Static FOV	Dynamic FOV	Working Distance	Clear Aperture	Lens Weight
OI-60M	1.00x	1.00x	85°	154°	10mm	29mm	32g

INDIRECT LENSES USE CLEANING METHOD 2  
MaxAC® AUTOCLAVABLE LENSES USE METHOD 3



### OCULAR MAXFIELD® 66D

Static field of view to the arcades. **Larger stereoscopic field than 60D.** Available with red, blue, green, gold, purple, or traditional black holding ring. Now available with our NEW Laserlight® HD anti-reflective coating. See Coatings and Materials (page 62) for more details.

Product Code	Image Mag.	Laser Spot Mag.	Static FOV	Dynamic FOV	Working Distance	Clear Aperture	Lens Weight
OH-66M	.91x	1.10x	91°	144°	8mm	27mm	25g



### OCULAR MAXFIELD® 72D

Performance like a 78D with a little more magnification. **Unique design minimizes reflections.** Available with red, blue, green, gold, purple, or traditional black holding ring. Now available with our NEW Laserlight® HD anti-reflective coating. See Coatings and Materials (page 62) for more details.

Product Code	Image Mag.	Laser Spot Mag.	Static FOV	Dynamic FOV	Working Distance	Clear Aperture	Lens Weight
OH-72M	.83x	1.20x	102°	155°	7mm	27mm	21g



### OCULAR MAXFIELD® HIGH MAG 78D

**Traditional 78D.** Made of high transmittance glass and featuring a wavefront optimized double aspheric design that yields an extremely wide field and sharp image. Available with red, blue, green, gold, purple, or traditional black holding ring. Now available with our NEW Laserlight® HD anti-reflective coating. See Coatings and Materials (page 62) for more details.

Product Code	Image Mag.	Laser Spot Mag.	Static FOV	Dynamic FOV	Working Distance	Clear Aperture	Lens Weight
OH-HM-78M	.98x	1.02x	88°	154°	10mm	29mm	32g

Ocular Indirect Lenses come with Laserlight® coating for maximum brightness and easy cleaning, see page 62.

MaxAC® autoclavable lenses are uncoated for sterilization compatibility.



**OCULAR OSHER MAXFIELD® 78D**

Formerly called the Osher Panfundus Lens. 78D high refractive index glass lens gives **wider field** than a traditional 78. Very high resolution and wide field for slit lamp fundus examination. **Unique design minimizes reflections.** Works very well with surgical microscope. Available with red, blue, green, gold, purple, or traditional black holding ring. Now available with our NEW Laserlight® HD anti-reflective coating. See Coatings and Materials (page 62) for more details.

Product Code	Image Mag.	Laser Spot Mag.	Static FOV	Dynamic FOV	Working Distance	Clear Aperture	Lens Weight
OI-78M	.77x	1.30x	98°	155°	7mm	27mm	21g



**OCULAR MAXFIELD® 84D**

Very high precision image. We call it the **Wide Field 90D** because it has more static field of view. Excellent for high resolution **digital** imaging. Available with red, blue, green, gold, purple, or traditional black holding ring. Now available with our NEW Laserlight® HD anti-reflective coating. See Coatings and Materials (page 62) for more details.

Product Code	Image Mag.	Laser Spot Mag.	Static FOV	Dynamic FOV	Working Distance	Clear Aperture	Lens Weight
OI-84M	.71x	1.40x	105°	158°	5mm	27mm	28g



**OCULAR MAXFIELD® STANDARD 90**

The most **popular power** for non-contact fundus examination. Large and small holding ring available. Also available with red, blue, green, gold, purple, or traditional black holding ring. Now available with our NEW Laserlight® HD anti-reflective coating. See Coatings and Materials (page 62) for more details.

Product Code	Image Mag.	Laser Spot Mag.	Static FOV	Dynamic FOV	Working Distance	Clear Aperture	Lens Weight
OI-STD	.75x	1.34x	94°	153°	5mm	19mm	9g
OI-STD-LR	.75x	1.34x	94°	153°	5mm	19mm	18g

INDIRECT LENSES USE CLEANING METHOD 2  
 MaxAC® AUTOCLAVABLE LENSES USE METHOD 3



### OCULAR MAXFIELD® 100D

**General screening lens.** Works well through small pupils. Available with red, blue, green, gold, purple, or traditional black holding ring. Now available with our NEW Laserlight® HD anti-reflective coating. See Coatings and Materials (page 62) for more details.

Product Code	Image Mag.	Laser Spot Mag.	Static FOV	Dynamic FOV	Working Distance	Clear Aperture	Lens Weight
OI-100M	.60x	1.67x	110°	146°	4mm	21mm	18g



### OCULAR MAXFIELD® 120D

High refractive index glass and precision aspheric design yield an **extremely wide field** and sharp image. **Excellent through small pupils**, 80° field of view through a 2mm pupil. Available with red, blue, green, gold, purple, or traditional black holding ring. Now available with our NEW Laserlight® HD anti-reflective coating. See Coatings and Materials (page 62) for more details.

Product Code	Image Mag.	Laser Spot Mag.	Static FOV	Dynamic FOV	Working Distance	Clear Aperture	Lens Weight
OI-120M	.50x	2.00x	120°	173°	4mm	21mm	19g



### OCULAR ULTRA VIEW SMALL PUPIL

132D lens permits detailed retinal inspection well outside the arcades. Primarily designed to examine patients with **small pupils**. Retains an 85° field of view through a 2mm pupil. Now available with our NEW Laserlight® HD anti-reflective coating. See Coatings and Materials (page 62) for more details.

Product Code	Image Mag.	Laser Spot Mag.	Static FOV	Dynamic FOV	Working Distance	Clear Aperture	Lens Weight
OI-SP	.45x	2.22x	99°	158°	4mm	16mm	9g

Ocular Indirect Lenses come with Laserlight® coating for maximum brightness and easy cleaning, see page 62.

MaxAC® autoclavable lenses are uncoated for sterilization compatibility.



## OCULAR LANDERS WIDE FIELD VITRECTOMY LENS

155D lens produces wide angle inverted image. Allows panoramic viewing of far peripheral retina. Clear image in fluid or gas filled eye. Works well with hazy ocular media or through a small pupil. Steam sterilizable, can be quickly prepared for a demanding surgical schedule. Stable in tall sutured lens ring.



Product Code	Image Mag.	Lens Height	Static FOV	Dynamic FOV
OLIV-WF	.38x	12mm	130°	146°



## OCULAR LANDERS EQUATORIAL II VITRECTOMY LENS

91D wide angle lens. For procedures from the posterior pole to the equator. Provides greater magnification and detail than Landers Wide Field. Steam sterilizable for rapid re-use.

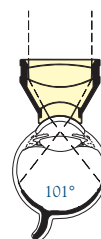

Product Code	Image Mag.	Lens Height	Static FOV	Dynamic FOV
OLIV-EQ-2	.65x	14.5mm	101°	131°



## OCULAR WOLDOFF HIGH MAGNIFICATION VITRECTOMY LENS

66D lens, ideal for wide angle viewing of the posterior pole. Its wide field provides stereopsis well beyond the area seen by a conventional flat lens. The high magnification and resolution create very precise depth perception. It provides an excellent image for delicate work around the macula such as macular hole surgery or peeling of epiretinal membranes from the macula. Lens of choice for videotaping macular procedures. Steam sterilizable for rapid re-use.



Product Code	Image Mag.	Lens Height	Static FOV	Dynamic FOV
OWIV-HM	.90x	13.5mm	57°	100°

LENSES ON THIS PAGE USE CLEANING METHOD 3

Ocular wide angle vitrectomy lenses are compatible with all detachable inverting systems



**OCULAR LANDERS NON-AUTOCLAVABLE WIDE FIELD VITRECTOMY LENS**

Single-piece, 155D lens designed for clinical situations where autoclaving is either not available or not desired. Excellent for panoramic viewing of the far peripheral retina and laser photocoagulation when managing a peripheral retinal tear or giant retinal tear. Its wide field of view and low magnification make it particularly useful during fluid-gas exchanges. Excellent lens for use with media opacities such as cataracts and cloudy corneas, and works well through a small pupil. It is the lens of choice for videotaping important procedures.



Product Code	Image Mag.	Lens Height	Static FOV	Dynamic FOV
OLIV-WFNA	.38x	12mm	130°	146°



**OCULAR LANDERS NON-AUTOCLAVABLE EQUATORIAL VITRECTOMY LENS**

Single-piece 91D lens designed for clinical situations where autoclaving is either not available or not desired. It is excellent for delicate membrane peeling around the optic nerve and off of the major vascular arcades. It also provides an excellent image for delicate work around the macula, such as macular hole surgery or peeling of epiretinal membranes from the macula.



Product Code	Image Mag.	Lens Height	Static FOV	Dynamic FOV
OLIVEQNA	.65x	14.5mm	101°	131°



**OCULAR WOLDOFF NON-AUTOCLAVABLE HIGH MAGNIFICATION VITRECTOMY LENS**

Single-piece, 66D lens designed for clinical situations where autoclaving is either not available or not desired. It is ideal for wide angle viewing of the posterior pole. Its wide field provides stereopsis well beyond the area seen by a conventional flat lens. The high magnification and resolution create very precise depth perception. It provides an excellent image for delicate work around the macula such as macular hole surgery or peeling of epiretinal membranes from the macula. It also is the lens of choice for videotaping macular procedures.

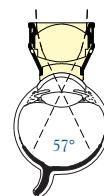

Product Code	Image Mag.	Lens Height	Static FOV	Dynamic FOV
OWIV-HMNA	.90x	13.5mm	57°	100°

LENSES ON THIS PAGE USE CLEANING METHOD 1  
**ASK ABOUT OUR DISCOUNTS ON MULTIPLE SETS!**

## OCULAR INVERTER VITRECTOMY SYSTEM



Designed to work with Zeiss, Zeiss type (Topcon, Moeller, etc.) and Leica (Wild) microscopes. Easy to operate with steam sterilizable knob. Short profile for use with all fixed and inclinable eyepieces. No light loss in upright mode. Virtually no image shift when switching between upright and inverting modes. Crystal clear optics. Compatible with all wide angle inverting vitrectomy lenses. Available with Ocular Wide Angle Vitrectomy Lenses.

### Product Code

OIVSL IVS for Leica (Wild) Microscopes  
 OIVSZ IVS for Zeiss and Zeiss Type Microscopes

### **INCLUDES:**

#### Product Code

OIVS-K Rubber Adjustment Knob (steam sterilizable)  
 OIVS-SD Screw Driver, slotted, 3/16"  
 OIVS-C Carrying Case (shown in Cases, p. 56)



## OCULAR VITRECTOMY LENS HANDLE

Designed to be used with the Wide Field and Equatorial lenses, the handle provides additional stability to the lens while sitting in the ring during a procedure.

### Product Code

OLIV-H

OLIV-H USES CLEANING METHOD 3

Buy in sets  
**AND SAVE!**



**IN ADDITION, IVS SETS INCLUDE:**

PRODUCT CODE	WF	EQ II	HM	WFNA	EQNA	HMNA	Handle	Ring
OIVSL-WE	1	1					2	1
OIVSL-EH		1	1				1	1
OIVSL-WH	1		1				1	1
OIVSL-WEH	1	1	1				2	1
OIVSL-WENA				1	1		2	1
OIVSL-EHNA					1	1	1	1
OIVSL-WHNA				1		1	1	1
OIVSL-WEHNA				1	1	1	2	1
OIVSZ-WE	1	1					2	1
OIVSZ-EH		1	1				1	1
OIVSZ-WH	1		1				1	1
OIVSZ-WEH	1	1	1				2	1
OIVSZ-WENA				1	1		2	1
OIVSZ-EHNA					1	1	1	1
OIVSZ-WHNA				1		1	1	1
OIVSZ-WEHNA				1	1	1	2	1

All products in this section are also available separately. 

**NEW OCULAR REICHEL VISCOUS CONTACT SYSTEM**

Integrates lens handle and delivery of viscoelastic or other solutions into one system. Designed for use with 5ml syringe\*, which is not included. Can be bent as desired to suit individual preference. Designed to be used with all Ocular Instruments Wide Field and Equatorial vitrectomy lenses.

Product Code

ORVCS

\*Can be used with BD 5ml syringe #309603 and BD Angiocath IV catheter #318123 (Remove needle prior to use). Recommended length of flexible catheter is 3-4mm, check for clearance between tip and patients eye prior to use.

Journal reference: *Ophthalmic Surgery Lasers & Imaging*, Vol. 40, No. 6, pp. 611-612, November / December 2009.

**OCULAR LANDERS FOUR POST VITRECTOMY LENS RING**

Two sutures placed over one post on each side hold this ring on the eye. Either post can be selected to center the ring over the patient's pupil.

Product Code

OLV-1-4P

OLV-1-4P USES CLEANING METHOD 3





## OCULAR PEYMAN-WESSELS-LANDERS 132D UPRIGHT VITRECTOMY LENS

Upright Wide Field Image without the need for a microscope mounted inverter. The 132D imaging optic gives a very wide, non-contact view of the fundus and vitreous. Unlike conventional wide angle lenses, the image of this lens is upright to simplify vitreo-retinal surgery. 4mm working distance for maximum field. 7mm working distance allows view of far periphery without repositioning the lens. This lens was designed to be used with the Ocular Landers Wide Angle Surgical Viewing System (OSVS). It attaches to the OSVS using the Ocular 132D Upright Vitrectomy Lens Holder (OUV-H132-2). Designed to allow a clear view in the fluid or air filled eye. Sterilizable case included.

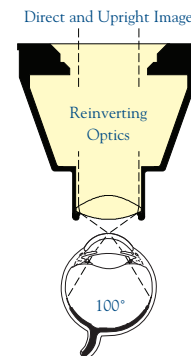

Product Code	Image Mag.	Static FOV	Dynamic FOV
OUV-132-2	.45x	100°	135°

*Journal reference: American Journal of Ophthalmology, Vol. 136, No. 1, pp 199-201, July 2003.*



## OCULAR 132D UPRIGHT VITRECTOMY LENS HOLDER

Ring holder for the Peyman-Wessels-Landers 132D Upright Vitrectomy Lens. Includes two adjustable links that snap onto the end of the slotted arm of the Surgical Viewing System.

Product Code
OUV-H132-2



## OCULAR 132D INDIRECT VITRECTOMY LENS

Designed to be used on the OSVS in conjunction with an Inverter Vitrectomy System. Sterilizable case included. Non-contact design allows the patient's eye to be rotated freely to view the peripheral retina and vitreous.

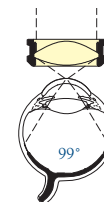

Product Code	Image Mag.	Static FOV	Dynamic FOV
OIV-132	.45x	99°	135°



## OCULAR 132D INDIRECT VITRECTOMY LENS HOLDER

Clip style holder for the Indirect 132D Upright Vitrectomy Lens. Includes two adjustable links that snap onto the end of the slotted arm of the Surgical Viewing System.

Product Code
OIV-H132

OUV-132-2 USES CLEANING METHOD 1;  
ALL OTHER PRODUCTS ON THIS PAGE USE CLEANING METHOD 3

## OCULAR LANDERS WIDE ANGLE SURGICAL VIEWING SYSTEM

Non-contact vitrectomy system designed with a flexible arm for positioning wide angle lenses which easily swings in and out of the surgical field. The OSVS [clamps] attaches to the wrist rest or surgical bed, freeing the surgeon's hands and the assistant to perform tasks other than holding a lens. When used with the Upright Vitrectomy Lens, the system allows the surgeon to work in the vitreous with an upright, non-reversed image under panoramic conditions. Can also hold an indirect lens for use with separate inverter. During surgery, operative work is performed both outside and inside the globe. Using lenses with the OSVS enables the surgeon to move back and forth smoothly and quickly. More affordable than similar systems.



Product Code  
OSVS

### INCLUDES:

Qty	Product Code	Description
1	OSVS-A	Arm, Slotted
1	OSVS-AC	Arm Clamp
1	OSVS-FC	Frame Clamp
2	OSVS-LFM	Link, Female/Male (extras)
2	OSVS-P	Post - 2 qty
1	OSVS-SC	Support Collar
1	OSVS-C	Carrying Case
1	OSVS-W	Wrench
2	OSVS-TS	Knobs (2 extra)

IN ADDITION, SVS SETS INCLUDE:				
PRODUCT CODE	OUV 132-2	OIV 132	Lens Holder	Lens Case
OSVS-U132-2	1		1	1
OSVS-I132		1	1	1

All products in this section are also available separately.

USE CLEANING METHOD 3

## SURGICAL LENSES



### OCULAR DISPOSABLE VITRECTOMY LENSES

High resolution PMMA optics with a silicone flange for stability. Ocular Disposable Vitrectomy Lenses are designed to be used once, then discarded. Packaged individually in a sterile peel pack, and sold in a box of 10. The silicone flange replaces the need for a suture-down ring.



#### 1. ODVB – BICONCAVE

83D biconcave lens facilitates viewing the fundus in an air-filled vitreous cavity in phakic and pseudophakic eyes.

#### 2. ODVF – FLAT

The plano anterior surface affords a 36° field of view of the central posterior pole and vitreous in phakic and pseudophakic eyes. This lens is ideal for photography.

#### 3. ODVM – MAGNIFYING

For detailed examination and minute surgical manipulation of retinal membranes in phakic and pseudophakic eyes.

#### 4. ODVW – WIDE FIELD

Concave anterior surface facilitates a 48° field of view when visualizing the central posterior pole and vitreous in phakic and pseudophakic eyes.

#### 5. ODV3P – 30° PRISM

Provides visualization of the posterior peripheral fundus and vitreous beyond the equator with minimal distortion in phakic, aphakic and pseudophakic eyes.

## LANDERS HIGH REFRACTIVE INDEX (HRI) VITRECTOMY LENS SET

Made from high refractive index glass, the HRI lenses offer a wider field of view, with less distortion and reflections. Each possesses new curves and angles, resulting in sharper, clearer peripheral and posterior retinal and vitreous images when compared with earlier lenses. This means fewer lens changes during the surgical procedure. The Landers Tall Notched Lens Ring (no struts) makes scleral depression easier when operating in the region of the vitreous base. The Landers Occluder fits precisely in the lens ring and protects the macula from inadvertent light/photo damage. Set also includes five vitrectomy lenses, lens forceps, and an autoclavable case.



### OLVS-HRI

Landers HRI Vitrectomy Lens Set includes:

1. **OLV-2-HRI** Biconcave 90D Lens  
90D biconcave lens facilitates viewing the fundus in an air-filled vitreous cavity in phakic and pseudophakic eyes.
2. **OLV-3-HRI** Magnifying Lens  
For detailed examination and minute surgical manipulation of retinal membranes in phakic and pseudophakic eyes.
3. **OLV-4-HRI** Wide Field Lens  
Plano anterior surface facilitates a 48° field of view when visualizing the central posterior pole and central vitreous in phakic and pseudophakic eyes.
4. **OLV-6-HRI** 20° Prism Lens  
Provides visualization of the posterior peripheral fundus and posterior peripheral vitreous in phakic, aphakic and pseudophakic eyes.
5. **OLV-7-HRI** 30° Prism Lens  
Provides visualization of the peripheral fundus and peripheral vitreous beyond the equator with minimal distortion in phakic, aphakic and pseudophakic eyes.
6. **OLV-1-TN** Landers Tall Notched Vitrectomy Lens Ring  
This stainless steel ring is centered on the cornea. Three notches are designed in the top of the ring for suture placement on the sclera.
7. **OLV-OC** Landers Occluder  
When placed in stainless steel ring, occluder blocks microscope light from entering patient's eye during external procedures such as suturing.
8. **OLV-FCP** Landers Lens Forceps  
Surgical forceps simplify placement and removal of vitrectomy lenses used with suture down rings.



OLV-2-HRI



OLV-3-HRI

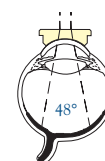

OLV-4-HRI



OLV-6-HRI

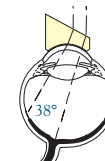

OLV-7-HRI

HRI VITRECTOMY LENS SPECIFICATIONS		
PRODUCT CODE	Image Mag	Static FOV
OLV-2-HRI	0.78x	28°
OLV-3-HRI	1.49x	34°
OLV-4-HRI	0.58x	48°
OLV-6-HRI	0.58x	44°
OLV-7-HRI	0.58x	38°

DOT ON ANTERIOR SURFACE IDENTIFIES HRI LENS

QUARTZ VITRECTOMY LENS SPECIFICATIONS		
PRODUCT CODE	Image Mag	Static FOV
OLV-2	0.80x	25°
OLV-3	1.49x	30°
OLV-4	0.49x	48°
OLV-5	1.02x	36°
OLV-5SR	1.02x	36°
OLV-6	1.02x	36°
OLV-7	1.02x	33°
OLV-8	1.02x	22°
OLV-9	0.40x	18°

TRY SILICONE RINGS - HIGH STABILITY WITHOUT SUTURES

PRODUCTS ON THIS PAGE USE CLEANING METHOD 3

## OCULAR LANDERS VITRECTOMY LENS RING SYSTEM

The Landers Vitrectomy Lens Ring System is available with your choice of the Landers Vitrectomy Lens Ring with two struts, or the Landers Tall Notched Vitrectomy Lens Ring (no struts), and includes the Landers Occluder, seven vitrectomy lenses, lens forceps and an autoclavable case.



### OLVS-3 AND OLVS-3N

Ocular Landers Vitrectomy Lens Ring System includes:

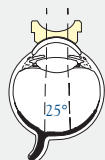

OLV-2

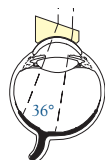

OLV-6

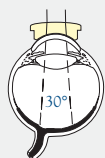

OLV-3



OLV-7

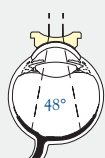

OLV-4



OLV-9

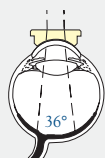

OLV-5

1. **OLV-2** Landers Biconcave  
83D biconcave lens facilitates viewing the fundus in an air-filled vitreous cavity in phakic and pseudophakic eyes.
2. **OLV-3** Machemer Magnifying  
For detailed examination and minute surgical manipulation of retinal membranes in phakic and pseudophakic eyes.
3. **OLV-4** Peyman Wide Field  
Concave anterior surface facilitates a 48° field of view when visualizing the central posterior pole and vitreous in phakic and pseudophakic eyes.
4. **OLV-5** Machemer Flat  
The plano anterior surface affords a 36° field of view of the central posterior pole and vitreous in phakic and pseudophakic eyes. This lens is ideal for photography.
5. **OLV-6** Tolentino 20° Prism  
Provides visualization of the posterior peripheral fundus and vitreous in phakic, aphakic and pseudophakic eyes.
6. **OLV-7** Tolentino 30° Prism  
Provides visualization of the peripheral fundus and vitreous beyond the equator with minimal distortion in phakic, aphakic and pseudophakic eyes.
7. **OLV-9** Woldoff Prismatic Biconcave  
Designed to allow a clear view of the retinal periphery in the gas or air-filled phakic or pseudophakic eye. Very useful for laser endophotocoagulation in the periphery, or for visualizing the cannulated extrusion needle through a peripheral retinal break in the gas-filled phakic or pseudophakic eye.
8. **OLV-1** Landers Vitrectomy Lens Ring  
(included in set OLVS-3) Stainless steel ring with two suture down struts.
9. **OLV-1-TN** Landers Tall Notched Vitrectomy Lens Ring  
(included in set OLVS-3N) This stainless steel ring is centered on the cornea. Three notches are designed in the top of the ring for suture placement on the sclera.
10. **OLV-OC** Landers Occluder  
When placed in stainless steel ring, occluder blocks microscope light from entering patient's eye during external procedures such as suturing.
11. **OLV-FCP** Landers Lens Forceps  
Surgical forceps simplify placement and removal of vitrectomy lenses used with suture down rings.

**PRODUCTS SOLD IN SETS ARE ALSO AVAILABLE SEPARATELY.**

PRODUCTS ON THIS PAGE USE CLEANING METHOD 3

## OCULAR VITRECTOMY LENS RINGS

### NEW OFV-4 FOXMAN VITRECTOMY

Designed to be stable on the eye by straddling the inserted trocar thus not requiring sutures. Struts are spaced for a 2.4mm wide trocar and have markings at 3mm and 4mm from the limbus.

### OLV-1S LANDERS SILICONE

This flexible lens flange provides uncompromised lens stability during vitrectomy surgery. The silicone ring can be used with all Ocular wide field and Landers System vitrectomy lenses. The narrow flange allows full access to the surgical sites and is ideal for 25 gauge surgery. Four per package.

### OLV-1-4P LANDERS FOUR POST

Two sutures placed over one post on each side hold this ring on the eye. Either post can be selected to center the ring over the patient's pupil.

### OLV-1-IN LANDERS IRRIGATING NOTCHED

Irrigation version of notched ring. To order a replacement Luer Tube Assembly order the OLTA, see accessory section.

### OLV-1-IR LANDERS IRRIGATING

This ring features an irrigation port. Sutures secure the two struts to the sclera which allows blood to be irrigated away and keeps the cornea moist. To order a replacement Luer Tube Assembly order the OLTA, see accessory section.

### OTN-R TANO VITRECTOMY LENS RING

This ring, with four upright tabs for suturing, requires only one circumferential suture. Fast, easy positioning, adjustment and removal without cutting or removing the suture.

*Journal Reference: Ophthalmic Surgery & Lasers, Vol. 27, No. 10, p. 891, October 1996*

### ALSO AVAILABLE:

### OLV-5SR OCULAR MACHEMER PLUS

Our Machemer Flat Lens (OLV-5) is provided with a silicone flange. This combination is for observation or surgery of the central retina and vitreous when the use of a suture down ring is not desired.

### OLV-8 OCULAR LANDERS 50° PRISM

Allows visualization for vitrectomy and endophotocoagulation procedures in the far peripheral retina in phakic and pseudophakic eyes.

### NEW OCULAR REICHEL VITRECTOMY LENS HOLDER

The Reichel Vitrectomy Lens Holder allows the use of vitrectomy lenses with the Ocular Reichel Viscous Contact System (ORVCS, see page 39). Vitrectomy lenses are conveniently transformed into a handheld lens by using the Vitrectomy Lens Holder. Designed for use with the following lenses: OLV-2-HRI, OLV-3-HRI, OLV-4-HRI, OLV-3, OLV-4, OLV-5, ODVE, and ODVW. The ORVCS is sold separately.

#### Product Code

ORVLH

*Journal reference: Ophthalmic Surgery Lasers & Imaging, Vol. 40, No. 6, pp. 611-612, November / December 2009.*

PRODUCTS ON THIS PAGE USE CLEANING METHOD 3

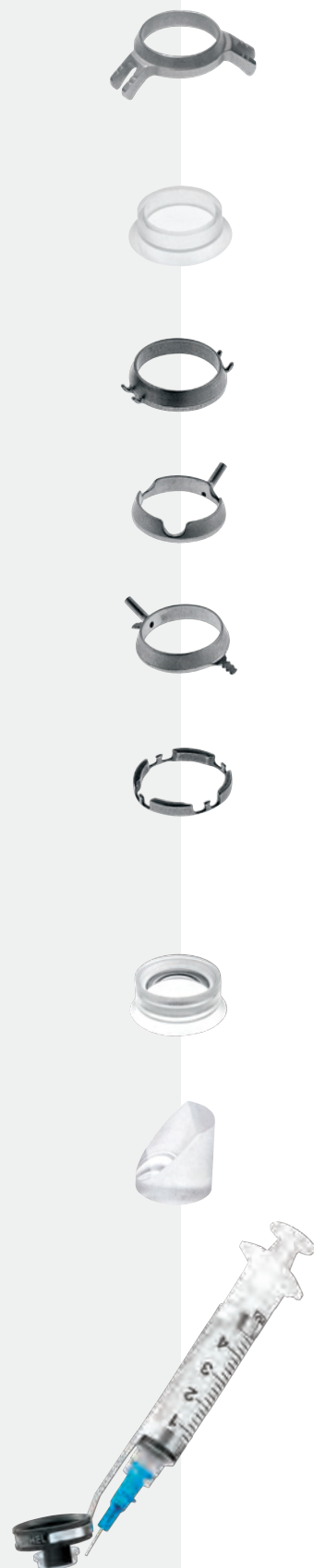

PEDIATRIC VITRECTOMY LENS SPECIFICATIONS		
PRODUCT CODE	Image Mag	Static FOV
OPV-B	1.03x	25°
OPV-F	1.02x	36°
OPV-P	1.02x	33°

## OCULAR PEDIATRIC VITRECTOMY LENS SET

The Pediatric Vitrectomy Lens Set is for early Retinopathy of Prematurity and congenital developmental anomalies such as Primary Persistent Hyperplastic Vitreous. These 8mm diameter lenses provide a clear view of the entire retina and optic nerve while preventing accidental lens/cornea separation which often occurs with large adult lenses. A groove on the side of the lens allows securing with 3.0 orthopedic suture wire or the lens ring may be used. Set includes three lenses, lens ring, forceps and an autoclavable case.

### OPV-S

Ocular Pediatric Vitrectomy Lens Set includes:

#### OPV-B Pediatric Biconcave

92D lens allows clear view of fundus in an air filled vitreous cavity in phakic eyes.



#### OPV-F Pediatric Flat

For visualizing the central posterior and central vitreous in a fluid filled eye.



#### OPV-P Pediatric Prism

Allows peripheral viewing beyond the equator with minimal distortion.

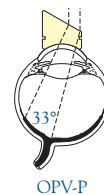

#### OPV-R Pediatric Vitrectomy Lens Ring

Stainless steel ring with two suture down struts.

#### OPV-FCP Pediatric Lens Forceps

Surgical forceps simplify placement and removal of vitrectomy lenses used with suture down rings.



PRODUCTS ON THIS PAGE USE CLEANING METHOD 3



## OCULAR HEXAGONAL VITRECTOMY LENSES

Ergonomically designed hexagonal infusion handle makes these lenses easy to hold and manipulate. Female Luer hub built in to end of handle. Unique ring design keeps infusion cannula out of the surgical field even at steep tilt angles. Four styles: Flat, Biconcave, Magnifying, and Wide Field. Steam Sterilizable. To order a replacement Luer Tube Assembly order the OLTA-2, see accessory section.

Product Code	Style	Image Mag.	Contact Diameter	Static FOV
OHFVE	Flat	1.02x - fluid filled	11.8mm	36°
OHMVE	Magnifying	1.47x - fluid filled	11.8mm	30°
OHBVE	Biconcave	0.80x - air filled	11.8mm	24°
OHWVE	Wide Field	0.49x - fluid filled 1.12x - air filled	11.8mm	48°



## OCULAR LANDERS BICONCAVE VITRECTOMY LENS

Designed for vitreoretinal surgery in air filled phakic or pseudophakic eyes. Lens power 83D. Red infusion handle for easy identification. To order a replacement Luer Tube Assembly order the OLTA, see accessory section.

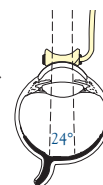

Product Code	Image Mag.	Contact Diameter	Static FOV
OBVI	.80x - air filled	9mm	24°

## OCULAR FLAT VITRECTOMY LENS

Used to visualize structures deep in the vitreous cavity or on retinal membranes. Plano anterior surface affords a 36° static field of view of the central posterior pole and vitreous in phakic and pseudophakic eyes. Very lightweight and can be used to tilt or indent the eye during surgery. Purple infusion handle for easy identification. The OPFVI has a smaller contact diameter for pediatric patients. To order a replacement Luer Tube Assembly order the OLTA, see accessory section.

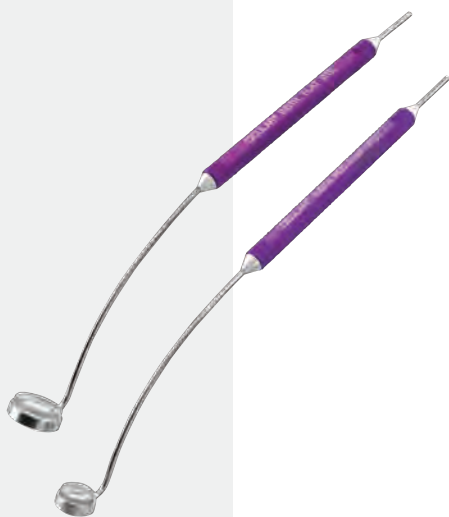
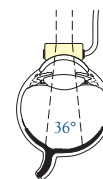

Product Code	Image Mag.	Contact Diameter	Static FOV
OFVI	1.02x - fluid filled	10mm	36°
OPFVI	1.02x - fluid filled	7mm	36°

LENSES ON THIS PAGE USE CLEANING METHOD 3



### OCULAR MACHEMER MAGNIFYING VITRECTOMY LENS

High magnification for delicate macular surgery. Works with phakic, pseudophakic and aphakic patients. Blue infusion handle for easy identification. To order a replacement Luer Tube Assembly order the OLTA, see accessory section.

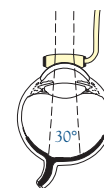

Product Code	Image Mag.	Contact Diameter	Static FOV
OMVI	1.47x – fluid filled	10mm	30°



### OCULAR PEYMAN-GREEN FLUID CELL VITRECTOMY LENS

Plano anterior surface is recessed 3mm. Balanced salt solution or methylcellulose added to the top of the lens creates a wider field of view through a meniscus lens effect. Green infusion handle for easy identification. To order a replacement Luer Tube Assembly order the OLTA, see accessory section.

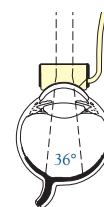

Product Code	Image Mag.	Contact Diameter	Static FOV
OPGVI	1.02x – fluid filled	12mm	36°



### OCULAR PEYMAN III WIDE FIELD VITRECTOMY LENS

60D anterior surface for wide angle viewing in phakic and pseudophakic eyes. Allows visualization of the peripheral fundus for endo-photocoagulation in fluid or air filled vitreous. To order a replacement Luer Tube Assembly order the OLTA, see accessory section.

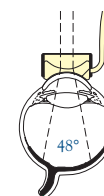

Product Code	Image Mag.	Contact Diameter	Static FOV
OPVI-3	0.49x – fluid filled	12mm	48°
	1.12x – air filled	12mm	

Journal Reference: Canadian Journal of Ophthalmology, June 1988

LENSES ON THIS PAGE USE CLEANING METHOD 3





## OCULAR PEYMAN PEDIATRIC WIDE FIELD VITRECTOMY LENS

A two-piece lens designed for clinical situations where autoclaving is the primary method used for sterilization. Excellent for panoramic viewing of the far peripheral retina for both premature infants and adult patients. Designed to reduce image cropping from lens tilt on the eye. Indirect image - best used with image inverter.



Product Code	Gonio Mag.	Contact Diameter	Static FOV
OPPVW	.50x	7mm	94°

Journal reference: American Journal of Ophthalmology, pp. 236-237, February 2003.

## NEW OCULAR DOUBLE MIRROR SURGICAL GONIO LENS



The Ocular Double Mirror Surgical Gonio Lens is designed for easy manipulation during goniotomy and direct viewing gonioscopy procedures, including goniosynechialysis. The two mirror design redirects the oblique gonio image to the coaxial surgical position, allowing the surgeon easy 360° viewing of the anterior chamber. The central view is used to observe instruments passing across anterior chamber. 1.20x image magnification for increased detail of anterior chamber structures. The lens combines the most favorable features of traditional gonioprisms while providing a properly orientated view of the angle. Large limbal aperture to simplify surgery by improving access to clear cornea. Lens is Steam Sterilizable. Works best with coaxial light source.



Product Code	Gonio Mag.	Contact Diameter	Lens Height	Static FOV
ODMSG	1.20x	9mm	49mm	90°

\*US Patent #7,419,262 B2

## OCULAR HILL SURGICAL GONIOPRISM

Designed for easy manipulation during goniotomy procedures and direct viewing gonioscopy procedures. An extended flange helps to fixate the globe during surgical procedures. Wide field of view lens provides a clear view of anterior chamber and anterior chamber angle during implantation and goniotomy procedures. Available in both left hand and right hand versions.



Product Code	Gonio Mag.	Contact Diameter	Static FOV
OHSG-LH	1.20x	9mm	90°
OHSG-RH	1.20x	9mm	90°

## OCULAR KHAW SURGICAL GONIOPRISM

Creates a bright, clear image of the anterior chamber angle for goniotomy and intra-operative gonioscopy. This unique design features a fixation ring and handle to provide stabilization and easy manipulation of the globe.

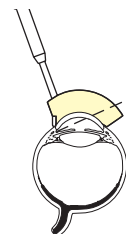

Product Code	Image Mag.	Contact Diameter	Handle Length
OKSG	1.40x	11.5mm	88.5mm

OKSG USES CLEANING METHOD 1; ALL OTHER PRODUCTS ON THIS PAGE USE CLEANING METHOD 3

**NEW OCULAR MORI UPRIGHT SURGICAL GONIO LENS**

The Mori Upright Surgical Gonio Lens is designed for glaucoma procedures, including goniosynechialysis. The two mirror design redirects the oblique gonio image to the coaxial surgical position, allowing the surgeon easy 360° viewing of the anterior chamber. The central view is used to observe instruments passing across anterior chamber. The lens combines the most favorable features of traditional gonioscopes while providing a properly orientated view of the angle. Large limbal aperture to simplify surgery by improving access to clear cornea.

Product Code	Gonio Mag	Contact Diameter	Lens Height	Static FOV
OMUSG	.80x	11.5mm	21.5mm	110°

Journal Reference: AJO, Vol. 143, No. 1, pp. 154-155, January 2007

**NEW OCULAR RITCH PANORAMIC SURGICAL GONIOPRISM**

The Ritch Panoramic Gonioscope is a glass lens designed for easy manipulation during goniotomy and direct viewing gonioscopy. The unique design leaves half the cornea closest to the surgeon exposed for use of instruments, incisions, and corneal retraction sutures. The lens provides 160° direct view of the angle. 180° can be seen with minimal rotation of the lens. The lens is steam sterilizable.

Product Code	Gonio Mag	Contact Diameter	Handle Length	Static FOV
ORPSG	.73x	10.8mm	77.5mm	160°

**OCULAR SWAN JACOB AUTOCLAVABLE GONIOPRISM**

Designed for direct viewing gonioscopy and goniotomy. Small size makes this lens useful for adult and pediatric postoperative gonioscopy. Anodized aluminum handle for easy manipulation. Glass design allows steam sterilization.

Product Code	Gonio Mag	Contact Diameter	Handle Length
OSJAG	1.20x	9.5mm	77.5mm

**OCULAR HOSKINS-BARKAN GONIOTOMY LENSES**

Designed for transverse goniotomy surgery with the operating microscope, but can also be used as a diagnostic lens. The infant lens is oval and conical in shape, with a 10mm diameter magnified view of the anterior chamber and anterior chamber angle. The premature infant lens is the same in shape and design except the dimension are 1mm smaller for premature infant surgery. An adult size of 11.5mm diameter is also available.

Product Code	Style	Size	Gonio mag
OHBG-1	Infant	10mm	1.30x
OHBG-2	Premature Infant	9mm	1.30x
OHBG-3	Adult	11.5mm	1.30x

**NEW OCULAR WELLS SUTURE MANIPULATOR LENS**

Lens was designed with a manipulating pin to adjust sclera flap sutures via the conjunctiva, after trabeculectomy procedures. The 1.29x magnification allows clear visualization of sutures and manipulating pin. The pin tip is smooth on all surfaces so that the conjunctiva is not damaged. Pin is tilted 10° towards center of lens to assist in engaging suture. This lens provides a more controlled alternative to laser suture lysis.

Product Code	Image Mag	Contact Diameter	Lens Height
OWSM	1.29x	5mm	22mm

OHBG-1, OHBG-2, OHBG-3 & OMUSG USE CLEANING METHOD 1  
OSJAG USES CLEANING METHOD 3

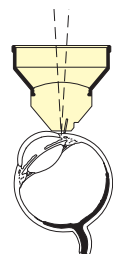
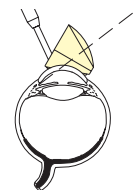
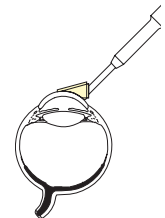
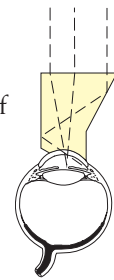



## OCULAR COBO TEMPORARY KERATOPROSTHESIS

The Cobo Temporary Keratoprosthesis is a truncated cone made of quartz and is autoclavable. Built into the keratoprosthesis is a superior groove that allows for suture fixation to the globe. The stainless steel infusion handle is used for injection of either fluid or gas for internal tamponade in the event of intraoperative hemorrhage or serious choroidal hemorrhage. The clear plano anterior surface allows intraoperative visualization of the posterior pole.

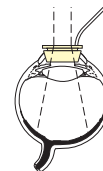

Product Code    Contact Diam    Handle Length

OCTK-6.5            6.5mm            40mm

\* The Cobo Temporary Keratoprosthesis is not CE certified.



## OCULAR LANDERS WIDE FIELD TEMPORARY KERATOPROSTHESIS

A 32D convex anterior surface facilitates viewing of the peripheral retina and posterior pole. 6 suture holes around the peripheral edge of the lens. Sutures hold keratoprosthesis in place and seal the eye for closed system vitrectomy. Two sizes for 7.0 or 8.0 trephination sizes. Vitrectomy lenses may be placed on top of the keratoprosthesis to alter magnification or field of view.

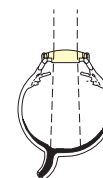

Product Code            Image Mag.            Contact Diam            Static FOV

OLTK-7.2                    2.29x                    7.2mm                    28°

OLTK-8.2                    2.29x                    8.2mm                    30°

*Journal Reference: American Journal of Ophthalmology, Vol. 122, No. 4, pp. 579-580, 1996  
Ophthalmology, Vol. 102, No. 12, pp. 1932-1935, December 1995*

\* The Landers Wide Field Temporary Keratoprosthesis is not CE certified.

## OSHER SURGICAL VIEWING KIT

An ideal combination of lenses to have on hand during **cataract surgery**. The Osher Surgical Gonio Posterior Pole Lens (OOSGP) gives an easy 360° view of the anterior chamber angle and a magnified view of the posterior pole. The Osher MaxField® 78D Lens (OI-78M) allows a wide field, non-contact view of the retina with minimal adjustment of the surgical microscope.

Product Code

OSVK

## OCULAR OSHER SURGICAL GONIO POSTERIOR POLE LENS

Two 60° gonioscopy mirrors. Posterior pole view through the center of lens. Handle design allows easy lens rotation for 360° anterior chamber angle viewing. Steam autoclavable for rapid surgical preparation. Retina image mag 1.02x.

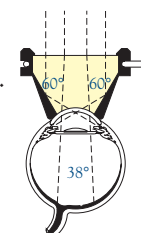

Product Code            Gonio Mag.            Contact Diameter            Static FOV

OOSGP                    .84x                    14mm                    38°



OLTK-7.2 AND OLTK-8.2 USE CLEANING METHOD 1  
OOSGP & OCTK-6.5 USE CLEANING METHOD 3

### OCULAR OSHER MAXFIELD® 78D



Formerly called the Osher Panfundus Lens. 78D high refractive index glass lens gives wider field than a traditional 78. Very high resolution and wide field for slit lamp fundus examination. Unique design minimizes reflections. Works very well with surgical microscope. Available with red, blue, green, gold, purple, or traditional black holding ring. Now available with our new Laserlight® HD anti-reflective coating. See coatings and materials (page 62) for more details.

Product Code	Image Mag.	Laser Spot Mag.	Static FOV	Dynamic FOV	Working Distance	Clear Aperture	Lens Weight
OI-78M	.77x	1.30x	98°	155°	7mm	27mm	21g

Osher Kit Lenses Also Available Separately.

## SLO LENSES

### OCULAR STAURENGHI 230 SLO RETINA LENS



Intended for use in conjunction with a confocal scanning laser ophthalmoscope (SLO) to visualize structures of the retina and ocular fundus. It is optimized for use in obtaining high-resolution wide field fluorescein and indocyanine green angiography images. Effective in obtaining fundus reflectance images with green and infrared light. Beneficial for diagnosis of diabetic retinopathy, peripheral retinal disorders such as hereditary chorioretinal disorders, inflammatory diseases, and to document retinoschisis and retinal detachment.

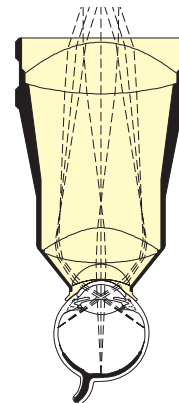

Product Code	Contact Diameter	Static FOV	Image Magnification
OSR230	19mm	150°	.23x

Journal reference: Arch Ophthalmol, Vol. 123, pp. 244-252, February 2005.

### OCULAR LEE-MAINSTER SLO LENS



The Ocular Lee-Mainster SLO Lens doubles the field of view of the Heidelberg Engineering HRA2 (30° setting gives 60° field of view). Instantaneous wide field of view imaging for peripheral dynamic angiography. Specially coated optics to reduce reflections and provide enhanced image contrast during fluorescein and indocyanine green angiography. Provides wide angle infrared images. Non-contact for ease and comfort of the patient.

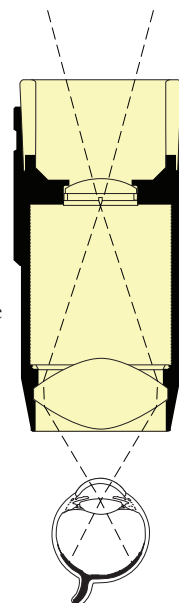

Product Code	Image Mag
OSLO60-2	.50x

LENSES ON THIS PAGE USE CLEANING METHOD 1  
OI-78M USES CLEANING METHOD 2

**NEW OCULAR 2MM FUNDUS LASER LENS**



Provides clear visualization of the ocular fundus and posterior pole. Conical shaped contact design for ease of use. AR coated plano anterior surface helps to reduce reflections and enhance the view. Ergonomic handle design for ease of manipulation. Designed for mice.

Product Code	Contact Diameter	Lens Height	Handle Length
OFA2.0	2mm	6.7mm	79mm

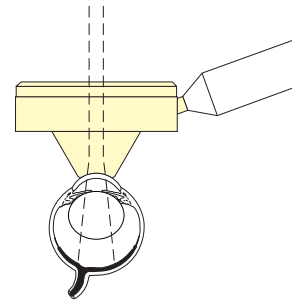

**OCULAR FUNDUS 5.4 LASER LENS**



Provides clear visualization of the ocular fundus and posterior pole. Plano anterior surface. Designed for rats.

Product Code	Contact Diameter	Lens Height	Handle Length
OFA5.4	5.4mm	5.9mm	79mm

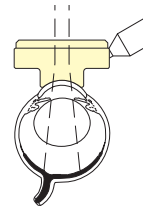

**OCULAR 2MM GONIOPRISM LENS**



Allows non-invasive visualization of the structures of the anterior chamber angle, including Schlemm's canal, trabecular meshwork, iris and anterior surface of the peripheral ciliary body. Designed for mice and rats but can be used to examine other animals. Excellent for goniophotography. High quality magnified views of the optic nerve, retinal vessels and posterior retina are easily obtained. Also available with a handle.

Product Code	Contact Diameter	Lens Height	Handle Length
OGP2	2mm	8.6mm	NA
OGP2H	2mm	8.6mm	79mm

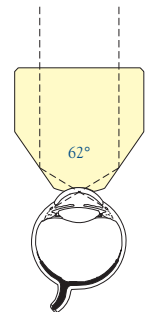

Journal Reference: *Molecular Vision* 2000, Vol. 8, pp. 26-31, February 2002

**OCULAR KAUFMAN LASER LENS**



Designed for visualization and laser procedures of the retina in all species of monkey. Single mirror lens is set at 64°. Two mirror lens has mirrors set at 67° and 76°. Ocular's Laserlight® high efficiency, broad band, anti-reflective coating provides optimal image contrast, minimizes bothersome reflections and maximizes visible near infrared (IR) laser transmission.

Product Code	Contact Diameter	Lens Height
OK2MA	13mm	19.5mm
OKSMA	13mm	19.5mm

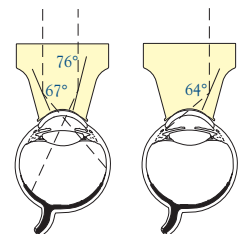

OCULAR RESEARCH LENSES USE CLEANING METHOD 1



### OCULAR HRA 20D LENS ADAPTER

The Ocular HRA 20D Lens Adapter slides over the objective lens of the HRA and holds a small 20D out in front of the HRA. The 20D changes the optics of the HRA resulting in a fairly wide field view of a rat retina.

Product Code

OHLA20

## TONOMETERS

### OCULAR BARRAQUER OPERATING ROOM TONOMETERS



Barraquer Tonometers are based on Maklakov's principle of applanation tonometry. By direct corneal contact, the meniscus ring can be compared to determine intraocular pressure.

#### OCULAR BARRAQUER 10-15 AND 15-21

Featuring the Terry dual calibration scale. Useful for many surgical applications. Two pressure ranges, 10-15mm Hg or 15-21mm Hg. The 15-21 is an excellent tool for vitreoretinal surgery during gas-fluid exchange.

Product Code      Contact Diam.      Lens Height

OBTTC-10-15      10mm      23.5mm

OBTTC-15-21      10mm      23.5mm



#### **NEW** OCULAR KASABY BARRAQUER 20-30MM HG TONOMETER

Two reticle ring diameters are calibrated to 20mm Hg and 30mm Hg. Valuable tonometer for comparing post cataract surgery intraocular pressure. Tonometer is made of durable clear acrylic. Can be flash steam autoclaved.

Product Code      Contact Diam.      Lens Height

OKBT-20-30      10.5mm      32.5mm

Journal Reference: *Journal of Cataract & Refractive Surgery*, Vol. 34, No. 2, pp. 258-261, February 2008



#### **NEW** OCULAR GRIFFIN BARRAQUER 30-50MM HG TONOMETER

Two reticle ring diameters are calibrated to 30mm Hg and 50mm Hg. Valuable tonometer for use during Descemet's stripping automated endothelial keratoplasty (DSAEK) procedure. Tonometer is made of durable clear acrylic. Can be flash steam autoclaved.

Product Code      Contact Diam.      Lens Height

OGBT-30-50      10.5mm      32.5mm

OCULAR TONOMETERS USE CLEANING METHOD 4



## OCULAR BARRAQUER 65

65mm Hg calibration scale measures the intraocular pressure when performing LASIK.

Product Code	Contact Diam.	Lens Height
OBT-65	10mm	47mm



## OCULAR BARRAQUER 65-90

Measures pressures ranging from 65-90mm Hg when performing LASIK. Two engraved ring reticles on the endpoint indicate a predetermined intraocular pressure of 65mm Hg or 90mm Hg. The smaller ring is 90mm Hg.

Product Code	Contact Diam.	Lens Height
OBT-65-90	8mm	72mm



## OCULAR BARRON BARRAQUER 65-90

Two engraved ring reticles on the endpoint indicate a predetermined intraocular pressure of 65mm Hg or 90mm Hg. The smaller ring is 90mm Hg. The tonometer is 2.76 inches long and designed to be used with the Barron microkeratome. The 8mm contact tip is useful with small internal diameter microkeratomes.

Product Code	Contact Diam.	Lens Height
OBBT	8mm	67mm



## OCULAR BARRAQUER VARLEY 90

90mm Hg calibration scale measures the intraocular pressure when performing LASIK. Compact design provides maximum working distance between tonometer and microscope.

Product Code	Contact Diam.	Lens Height
OBVT	8mm	56mm

## OCULAR BARRAQUER TONOMETER SILICONE RING (ACCESSORY FOR THE TONOMETERS ABOVE)

Replacement silicone ring, sold in a package of 5.

Product Code
OBT-O

OCULAR TONOMETERS USE CLEANING METHOD 4



## OCULAR FUNDUS EYE MODEL WITH EYE FILL KIT

Designed primarily to assist in teaching slit lamp biomicroscopy and ophthalmoscopy. Every effort has been made to duplicate pathological problems found in the human eye. Each model has a retinal detachment showing an elevated retina and retinal tear. It also displays a foreign body, optic disc and blood vessels. A line at the 180 degree meridian designates the region of the equator. A peg on the back of each model fits into the Ocular Eye Model Bracket (OEMB1 – Purchased Separately) which can be attached to the vertical post of the slit lamp chin rest.

Product Code	Description
OEM-F	8mm Fundus Eye Model



## OCULAR IMAGING EYE MODEL

The most realistic eye model available for Ocular fundus imaging. The unique design incorporates an anterior chamber, crystalline lens, and fundus. Model provides superior demonstration and training of common ophthalmic imaging devices. This eye model incorporates many useful features not available in other eye models, including a retinal detachment showing an elevated retina, a foreign body, optic disc, and blood vessels. In addition, fluorescent features within the eye allow simulated fluorescein imaging. A line at the 180° meridian designates the region of the equator. A peg on the bottom of the model fits into the Ocular Eye Model Bracket (OEMB1) which can be attached to the vertical post of the slit lamp chin rest.

Product Code	Style
OEMI-7	7mm Imaging Eye Model



## OCULAR EYE MODEL BRACKET

Designed with a position-adjustable post used to attach the eye model to the vertical post of the slit lamp chin rest.

Product Code
OEMB1



## OCULAR TABLE TOP EYE MODEL HOLDER

Holds eye model at 52° angle while allowing free rotation of the eye model. Particularly useful for teaching the use of the binocular indirect ophthalmoscope.

Product Code
OEMB2



## OCULAR EYE MODEL FILL KIT

Replacement fill kit includes a 3cc syringe, 21 gauge blunt needle, 1/16 hex key and a bottle of mineral oil.

Product Code
OEMFK





## OCULAR MULTI-LENS CASES

Walnut lens cases built to your specification. Contact our Customer Service department for a custom lens case order form.

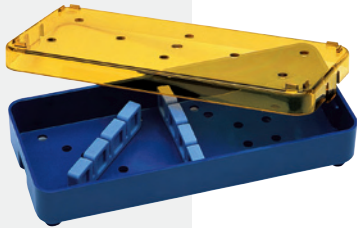

## OCULAR INDIRECT STERILIZING TRAY

Sterilizing tray for Ocular Indirect Ophthalmoscopy lenses. It makes ethylene oxide and cold sterilization of lenses quick and easy. This stackable, durable tray gently holds lenses to protect them during sterilization.

Product Code

OI-ST



## NEW OCULAR STERILIZATION/DISINFECTION LENS CASES

Sterilization/disinfection cases for Ocular lenses. An excellent choice for the autoclave. Also makes ethylene oxide and cold sterilization of lenses quick and easy. Several sizes available.

<u>Product Code</u>	<u>Style</u>
OLV-C	8 Lens
OLV-C2	2 Lens
OLV-C3	10 Lens
OLV-C3-HRI	10 Lens
OLV-C4	AC, (O4MAC, O4MAC-IR)
OLV-C5	6" x 2.5" x .75"
OLV-C6	6" x 2.5" x 1.25"
OLV-C7	2.65" x 1.54" x 1.75"
OLV-C8	6" x 10" x 1.5"



## OCULAR SURGICAL VIEWING SYSTEM CASES

Custom cut foam liner in a heavyweight black plastic case for transport and storage of Ocular Wide Angle Surgical Systems.

Product Code

OIVS-C

OSVSC



## OCULAR LENS CLEANING CLOTH

Light, dry-wipe, silky smooth microfiber cloth with Ocular logo imprint. Vinyl carrying case included. Autoclavable lens cleaning cloth also available.

### Product Code

OLCC	Blue, Traditional
OLCCA	White, Autoclavable



## OCULAR GONIOSCOPIIC SOLUTION HOLDER

Designed to hold an inverted gonioscopic solution container to minimize air bubbles. Made of heavy PMMA.

### Product Code

OGSH
------



## OCULAR MAXAC® (AUTOCLAVABLE) LENS STAND

The lens stand minimizes water spots from the autoclave. Use during sterilization to hold the lens or lens sterilization case on edge.

### Product Code

OHLA
------



## OCULAR THREE MIRROR LENS FLANGE

Flange designed to be installed on glass Ocular Autoclavable Three Mirror Lens (OG3MAC-10) and Ocular High Definition Three Mirror Lens (OG3MHD-10). Flange made of durable medical polymer, will not break during normal handling and use. Eliminates the need to purchase additional lenses with dedicated flanges. Flange cover is easily removed from the autoclavable glass lens for cleaning and sterilization. Compatible with most common disinfection and sterilization methods including steam sterilization.

Product Code	Flange Diameter
OACF-15	15mm
OACF-17	17mm



**OCULAR FOUR MIRROR LENS FLANGE**

Flange designed to be installed on the glass Ocular MaxField® Autoclavable Four Mirror Gonio Lens (O4MAC, O4MAC-1X, O4MAC-LR, O4MAC-1X-LR), and the Ocular Gaasterland Four Mirror Gonio Lens (OG4MG, OG4MG-1X, OG4MG-LR, OG4MG-1X-LR). Flange made of durable medical polymer, will not break during normal handling and use. Eliminates the need to purchase additional lenses with dedicated flanges. Flange cover is easily removed from the lens for cleaning and sterilization. Compatible with most common disinfection and sterilization methods including steam sterilization.

Product Code	Flange Diameter
OACF4-15	15mm
OACF4-17	17mm



**OCULAR KAPETANSKY WATER BATH**

Designed for ultrasound biomicroscopy, the saddle shape of the cup makes an ideal fit for the anterior sclera and thereby minimizes the loss of saline solution. The design makes it easier to install and more comfortable for the patient as compared to other currently used eye cups. In addition, the fluid reservoir attached to the top of the cup provides a depth of saline which is more than adequate for the ultrasonic probe to function properly. Steam Autoclavable.

Product Code
OKWB21

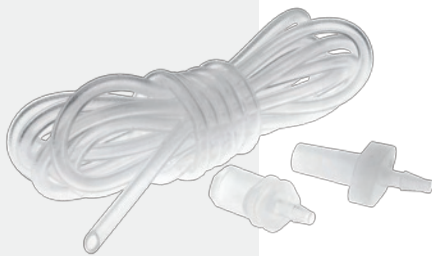

**OCULAR LUER TUBE ASSEMBLY**

Replacement Luer Tube Assembly for the vitrectomy infusion handled lenses.

Product Code	Style
OLTA	Replacement part for OBVI, OFVI, OPFVI, OMVI, OPGVI, OPVI-3, OLV-1-IN, OLV-1-IR
OLTA-2	Replacement part for OHBVE, OHFVE, OHMVE, OHWVE

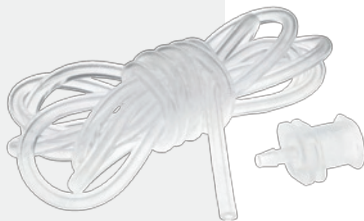



## OCULAR LENS PROTECTION RINGS

Lens protection rings slip over the top of lenses to guard against accidental scratches. Knurled edges provide a secure gripping surface.

Product Code	Style
OLPR-L	Large Lens
OLPR-M	Medium Lens
OLPR-RIT	Ritch Trabeculoplasty
OLPR-S	Small Lens
OLPR-SUS	Sussman
OLPR-SUS-2	Sussman Large Ring

# CLEANING METHODS

DEVICES	CLEANING		DISINFECTION	STERILIZATION					
	MILD SOAP	ALCOHOL WIPE	DISINFECTION	EO	FLASH AUTOCLAVE	STEAM AUTOCLAVE	ASP STERRAD	STERIS SYSTEM TE	3M OPTREOZ
<b>CLEANING METHOD 1</b> All Ocular Laser and Diagnostic Lenses and OKSG, OLIV-EQNA, OLIV-WFNA, OLTk-7.2, OLTk-8.2, OMUSG, OTSG, OUV-132-2, OWIV-HMNA	X		X	X			X	X	X
<b>Note:</b> OMRA-HM and OMRA-HM-2 are not compatible with Steris									
<b>CLEANING METHOD 2</b> All Ocular MaxField® Glass Indirect Diagnostic/Laser Lenses	X	X	X	X			X	X	X
<b>CLEANING METHOD 2</b> All Ocular MaxLight® CR-39 Indirect Diagnostic/Laser Lenses	X	X	X	X					X
<b>CLEANING METHOD 3</b> All Ocular Surgical Lenses and Rings and OI-20A, OI-28A, O4MAC, O4MAC-15, O4MAC-17, O4MAC-1X, O4MAC-1X-15, O4MAC-1X-17, O4MAC-H, O4MAC-1X-H, O4MAC-LR, O4MAC-LR-15, O4MAC-LR-17, O4MAC-1X-LR, O4MAC-1X-LR-15, O4MAC-1X-LR-17, OG3MAC-10, OG3MAC-15, OG3MAC-17	X		X	X	X	X	X	X	X
<b>Note:</b> For products with lumens please consult the sterilization manufacturer for compatibility.									
<b>CLEANING METHOD 4</b> All Ocular Tonometers	X		X	X	X			X	X

This chart is for general information only. Please see the Ocular Instruments Product Care Instructions which came with your product or are located on our website at [www.ocularinc.com](http://www.ocularinc.com) for specific product care instructions.

### CLEANING - MILD SOAP

- Rinse:** Immediately upon removal from patient's eye, thoroughly rinse in cool or tepid water to avoid soil drying on surfaces or lumens.
- Wash:** Place a few drops of low foaming mild soap (i.e., neutral pH (7.0) detergent formulated for medical instruments) on a moistened cotton ball. Gently clean with a circular motion until all soil has been removed. Flush all lumens with detergent solution to remove soil.
- Rinse:** Thoroughly rinse lens and flush lumens in cool or tepid high purity water, then dry carefully with a non-linting tissue or hospital grade compressed air.
- Inspect:** Visually inspect all surfaces, crevices, joints, holes and lumens for complete removal of soil and fluid. If any soil or fluid is visible, then repeat cleaning.
- Caution:** If fluid/gas exchange has occurred, wipe lens with alcohol to remove any trace of oil present. If lens is not promptly and properly cleaned, permanent damage may result.

### CLEANING - ALCOHOL WIPE

- Wipe:** Clean with alcohol wipe.
- Then:** Proceed with either disinfection or sterilization instructions.
- Caution:** If fluid/gas exchange has occurred, wipe lens with alcohol to remove any trace of oil present. If lens is not promptly and properly cleaned, permanent damage may result.

### DISINFECTION

Disinfectant solutions (e.g., Approved by FDA, DGHM, CE Mark...) may be used in accordance with label instructions of the disinfectant manufacturer. Pay strict attention to disinfectant manufacturers recommended concentrations and contact durations. Ensure that disinfectant solution makes complete contact with all device surfaces and lumens.

After manual high level disinfection, soak and rinse lens in large volume of cool or tepid sterile water for 1 minute and thoroughly flush lumens. Repeat this procedure 2 times with fresh rinse water to ensure removal of disinfection solution.

- Caution:** To avoid damage to the lens, do not exceed recommended exposure time.
- Caution:** If used on an ulcerated cornea, lens must be STERILIZED before next procedure.

### STERILIZATION

Please see the Ocular Instruments Product Care Instructions which came with your product or are located on our website at [www.ocularinc.com](http://www.ocularinc.com) for specific sterilization instructions.

### ADDITIONAL INFORMATION

Other forms of cleaning and sterilization equipment are available. Please consult instructions of the processing equipment or the manufacturer for compatibility claims. All cleaning and sterilization processes require validation at the point of use.

## **LASERLIGHT® ANTI-REFLECTIVE COATINGS**

### **OCULAR INSTRUMENTS RECOMMENDS YOU ORDER LENSES WITH ANTI-REFLECTIVE COATING FOR ALL YOUR DIAGNOSTIC PROCEDURES.**

The Laserlight® anti-reflective coatings provided with our indirect and laser lenses minimize reflection and maximize image brightness. The unique hydrophobic properties make Laserlight® coated lenses very easy to clean. Each coating type provides low reflectivity and high transmittance for the entire visible spectrum. Additionally, for non-visible lasers such as Nd:YAG lasers, the coating design has been enhanced for low reflectivity at the specific laser wavelength. In other words, Ocular YAG Lenses are compatible with visible and diode lasers, but Ocular Argon/Diode Lenses are not recommended for use with Nd:YAG lasers.

### **NEW LASERLIGHT® HD ANTI-REFLECTIVE COATING**

The new Laserlight® HD anti-reflective coating was specially designed to minimize reflection on high index lenses. The high definition images that can be achieved with this coating are ideal for digital imaging applications. Reflections are reduced 50-80% compared with traditional coatings. Laserlight® HD significantly increases image brightness and maximizes laser efficiency. Laserlight® HD has a more spectrally neutral reflection and yields a more natural image color palette. It surpasses MIL-C-48497 standard for coating durability and is highly scratch resistant.

### **CONSIDER SOME OF THE BENEFITS OF ANTI-REFLECTIVE COATINGS...**

Minimum reflection and enhanced image quality are essential considerations for slit lamp examinations. Many eye doctors are converting to exclusive use of laser lenses for diagnostic use because of significantly greater image clarity and resolution. For laser application, transmission of the treatment beam is maximized. This is important for optimizing the interaction of the laser energy with the target tissue. Reflectance of the aiming beam and slit lamp source is minimized. Although there is certainly a safety factor added by reducing these reflections, the primary benefit is an increase in image contrast and resolution of the treatment area.

## **LENS MATERIALS**

### **OPTICAL COMPONENTS**

All Ocular Instruments lenses are designed and manufactured using the finest grade optical polymers and glasses. Materials are chosen that best meet the performance requirements of each design. Total system design encompasses the primary requirements of optical image quality, sterilization method, durability and the essential elements of ergonomics, weight, and cost.

### **LATEX FREE PRODUCTS**

Ocular Instruments products do not contain latex.

## **GUARANTEE**

At Ocular Instruments, we take great pride in our reputation for manufacturing the world's highest quality ophthalmoscopic lenses. If, for any reason, an Ocular Instruments product does not meet your requirements or expectations, you may return it to us within 30 days of purchase for a full refund. *(Please contact customer service for RA#)*

All Ocular Instruments products are unconditionally guaranteed against defects in materials and workmanship within 1 year of the invoice date.

## **ORDERS**

Please contact your authorized Ocular Instruments distributor or contact us directly via mail, telephone, fax, email, or our web site. State complete description and product code. Please provide complete Shipping and Billing addresses with your order.

## **PAYMENT TERMS**

Net 30 days (Credit application and approval may be required.)

## **SHIPMENT OF GOODS**

Shipment of products is made by FedEx, air freight or USPS; F.O.B. shipping point. Bank fees, insurance and documentation charges are added when applicable. If shipment is prepaid, all costs are added to the invoice. All standard orders will be shipped within 10 days unless notified otherwise.

## **RETURN GOODS POLICY**

Merchandise is returnable for credit only with prior authorization from Ocular Instruments. It is recommended that all shipments to Ocular Instruments be made via UPS, prepaid and insured for full value. Please clean and disinfect all products prior to returning.

## **REPAIR SERVICE**

We offer full service repair for all of our products. We will inspect each item to determine if it is repairable. "Repairable" means that we can restore the product to a safe and effective condition in accordance with our quality system. If your product is repairable, we will provide a price quotation for your approval prior to performing the repair. In most cases, a repaired product will be restored to almost new condition. In order to expedite the repair process, please contact Customer Service for a return authorization number.



# ALPHABETICAL INDEX



	DESCRIPTION	CODE	PAGE		DESCRIPTION	CODE	PAGE
A	Abraham Capsulotomy	OAYA	14	G	Gaasterland 4 Mirror Gonio Diag	OG4MG	21
	Abraham Iridectomy	OAIA	9		Gaasterland 4 Mirror Gonio Diag	OG4MG-15	21
	Abraham Iridectomy YAG	OAIY	14		Gaasterland 4 Mirror Gonio Diag	OG4MG-17	21
	Autoclavable Case	OLV-C4	56		Gaasterland 4 Mirror Gonio Diag	OG4MG-H	21
	Autoclavable Case, 10 Lens	OLV-C3	56		Gaasterland 4 Mirror Gonio Diag	OG4MG-1X	21
	Autoclavable Case, 10 Lens HRI	OLV-C3-HRI	56		Gaasterland 4 Mirror Gonio Diag	OG4MG-1X-15	21
	Autoclavable Case, 2 Lens	OLV-C2	56		Gaasterland 4 Mirror Gonio Diag	OG4MG-1X-17	21
	Autoclavable Case, 8 Lens	OLV-C	56		Gaasterland 4 Mirror Gonio Diag	OG4MG-1X-LR	21
	Autoclavable Three Mirror Diag	OG3MAC-10	19		Gaasterland 4 Mirror Gonio Diag	OG4MG-1X-LR-15	21
	Autoclavable Three Mirror Diag	OG3MAC-15	19		Gaasterland 4 Mirror Gonio Diag	OG4MG-1X-LR-17	21
Autoclavable Three Mirror Diag	OG3MAC-17	19	Gaasterland 4 Mirror Gonio Diag	OG4MG-1X-H	21		
B	Barraquer (ECP) Tonometer	OBT-TC-10-15	53	Gaasterland 4 Mirror Gonio Diag	OG4MG-LR	21	
	Barraquer (Phaco & SLIP) Tonometer	OBT-TC-15-21	53	Gaasterland 4 Mirror Gonio Diag	OG4MG-LR-15	21	
	Barraquer 65mm Hg Tonometer	OBT-65	54	Gaasterland 4 Mirror Gonio Diag	OG4MG-LR-17	21	
	Barraquer 65/90mm Hg Tonometer	OBT-65-90	54	Gonioscopic Solution Holder	OGSH	57	
	Barraquer Tonometer Silicone Ring	OBT-O	54	Grid, Saxena Retinal 428	OI-SRG428	29	
	Barraquer Varley 90mm Hg Tonometer	OBVT	54	Grid, Saxena Retinal 520	OI-SRG520	30	
	Barron Barraquer 65/90mm Hg Tonometer	OBBT	54	Griffin Barraquer 30-50mm HG Tonometer	OGBT-30-50	53	
	C	Carrying Case, IVS	OIVS-C	56	H	Handle, Wide Angle Vitr Lens	OLIV-H
Carrying Case, SVS		OSVS-C	56	Hexagonal Biconcave Vitr Lens		OHBVE	46
Case, Autoclavable, 2 Lens		OLV-C2	56	Hexagonal Flat Vitr Lens		OHFVE	46
Case, Autoclavable, 8 Lens		OLV-C	56	Hexagonal Magnifying Vitr Lens		OHMVE	46
Case, Autoclavable, 10 Lens		OLV-C3	56	Hexagonal Wide Field Vitr Lens		OHWVE	46
Case, Autoclavable, 10 Lens HRI		OLV-C3-HRI	56	High Definition Three Mirror		OG3MHD-10	8, 19
Case, Autoclavable		OLV-C4	56	High Definition Three Mirror		OG3MHD-15	8, 19
Case, Autoclavable, 6" x 2.5" x 0.75"		OLV-C5	56	High Definition Three Mirror		OG3MHD-17	8, 19
Case, Autoclavable, 6" x 2.5" x 1.25"		OLV-C6	56	Hill Surgical Gonioscope, Left Hand		OHSG-LH	48
Case, Autoclavable, 2.65" x 1.54" x 1.75"		OLV-C7	56	Hill Surgical Gonioscope, Right Hand		OHSG-RH	48
Case, Autoclavable, 6" x 10" x 1.5"		OLV-C8	56	Holder, OIV-132 Lens		OIV-H132	40
Cleaning Cloth, Lens		OLCC	57	Holder, OUV-132-2 Lens		OUV-H132-2	40
Cleaning Cloth, Lens Autoclavable		OLCCA	57	Hoskins-Barkan Goniotomy Lens		OHBG-1	49
Cobo 6.5 Temp Keratoprosthesis		OCTK-6.5	50	Hoskins-Barkan Goniotomy Lens		OHBG-2	49
Contact System, Reichel Viscous		ORVCS	39	Hoskins-Barkan Goniotomy Lens		OHBG-3	49
D	Disposable, 30° Prism Vitr	ODV3P	41	I	Indirect Lens Sterilizing Tray	OI-ST	56
	Disposable, Biconcave Vitr	ODVB	41		Indirect Vitr 132D	OIV-132	40
	Disposable, Flat Vitr	ODVF	41		Inverter Vitr System (Leica)	OIVSL	38
	Disposable, Magnifying Vitr	ODVM	41		Inverter Vitr System (Zeiss)	OIVSZ	38
	Disposable, Wide Field Vitr	ODVW	41	K	Kapetansky Water Bath	OKWB21	58
	Double Mirror Surgical Gonio Lens	ODMSG	48		Karickhoff 21mm Vitreous Lens	OJKY-21	16
	E	Eye Model Bracket	OEMB1		55	Karickhoff, Diag, 18mm OD	OJK
Eye Model Fill Kit		OEMFK	55		Karickhoff, Diag, w/flange, 20mm OD	OJKF	18
Eye Model, Fundus 8mm		OEM-F	55		Karickhoff, Laser, 18mm OD	OJKA	9
Eye Model, Imaging		OEMI-7	55		Karickhoff, Laser, w/flange, 20mm OD	OJKFA	9
Eye Model, Table Top Eye Holder		OEMB2	55		Karickhoff Off-Axis Vitreous Lens	OJKPY-25	16
F		Flat Vitr Infusion (Purple)	OFVI		46	Kasaby Barraquer 20-30mm Hg Tonometer	OKBT-20-30
	Flat Vitr Infusion (Pediatric)	OPFVI	46		Kaufman 1M Research	OKSMA	52
	Four Mirror Lens Flange (15mm)	OACF4-15	58		Kaufman 2M Research	OK2MA	52
	Four Mirror Lens Flange (17mm)	OACF4-17	58	Khaw 4D 1X Direct View Gonio	OK4DG-1X	21	
	Four Mirror Mini Gonio Diag (NMR)	O4GF	20	Khaw 4D Direct View Gonio Diag	OK4DG	21	
	Four Mirror Mini Gonio Diag (NMR)	O4GF-LR	20	Khaw Surgical Gonioscope	OKSG	48	
	Four Mirror Mini Gonio Laser (NMR)	O4GFA	11	Koeppel, Large, 19mm Diag	OKL	23	
	Four Mirror Mini Gonio Laser (NMR)	O4GFA-LR	11	Koeppel, Medium, 18mm Diag	OKM	23	
	Foxman Vitrectomy Lens Ring	OFV-4	44	Koeppel, Small, 17mm Diag	OKS	23	
	Fundus 5.4 Research	OFA5.4	52	L	Landers Biconcave Lens 83D	OLV-2	43
	Fundus Diag	OGF	22		Landers Biconcave Vitr Infusion (Red)	OBVI	46
	Fundus Diag (NMR-K)	OGF-2	22		Landers Four Post Vitr Lens Ring	OLV-1-4P	39, 44
	Fundus Laser	OGFA	13		Landers 50° Prism	OLV-8	44
	Fundus Laser (NMR-K)	OGFA-2	13		Landers Equatorial II Vitr	OLIV-EQ-2	36

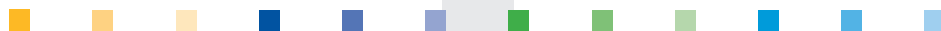

# ALPHABETICAL INDEX



	DESCRIPTION	CODE	PAGE		DESCRIPTION	CODE	PAGE	
L	Landers HRI 20° Prism Vitr	OLV-6-HRI	42	M	MaxField® AC 4 Mirror Gonio Diag	O4MAC-17	22	
	Landers HRI 30° Prism Vitr	OLV-7-HRI	42		MaxField® AC 4 Mirror Gonio Diag	O4MAC-LR	22	
	Landers HRI Biconcave 90D Vitr	OLV-2-HRI	42		MaxField® AC 4 Mirror Gonio Diag	O4MAC-LR-15	22	
	Landers HRI Magnifying Vitr	OLV-3-HRI	42		MaxField® AC 4 Mirror Gonio Diag	O4MAC-LR-17	22	
	Landers HRI Vitr Lens Set	OLVS-HRI	42		MaxField® AC 4 Mirror Gonio Diag	O4MAC-H	22	
	Landers HRI Wide Field Vitr	OLV-4-HRI	42		MaxField® AC 4 Mirror Gonio Diag	O4MAC-1X	22	
	Landers Irrigating Notched Vitr Lens Ring	OLV-1-IN	44		MaxField® AC 4 Mirror Gonio Diag	O4MAC-1X-15	22	
	Landers Irrigating Vitr Lens Ring	OLV-1-IR	44		MaxField® AC 4 Mirror Gonio Diag	O4MAC-1X-17	22	
	Landers Lens Forceps	OLV-FCP	42, 43		MaxField® AC 4 Mirror Gonio Diag	O4MAC-1X-LR	22	
	Landers NA Equatorial Vitr	OLIVEQNA	37		MaxField® AC 4 Mirror Gonio Diag	O4MAC-1X-LR-15	22	
	Landers NA Wide Field Vitr	OLIV-WFNA	37		MaxField® AC 4 Mirror Gonio Diag	O4MAC-1X-LR-17	22	
	Landers Notched Irrigating Vitr	OLV-1-IN	44		MaxField® AC 4 Mirror Gonio Diag	O4MAC-1X-H	22	
	Landers Occluder	OLV-OC	42, 43		MaxField® 14D Indirect	OI-14M	27	
	Landers ROP Lens Attachment	OI-LROP	29		MaxField® 18D Indirect	OI-18M	27	
	Landers Silicone Vitr Lens Ring	OLV-1S	44		MaxField® 20D Indirect	OI-20M	27	
	Landers Tall Notched Vitr	OLV-1-TN	42, 43		MaxField® 22D Indirect	OI-22M	28	
	Landers Vitr Lens Ring	OLV-1	43		MaxField® 25D Indirect	OI-25M	28	
	Landers Vitr Lens Ring System	OLVS-3	43		MaxField® 28D Indirect	OI-28M	28	
	Landers Vitr Lens Ring System	OLVS-3N	43		MaxField® 30D Indirect	OI-30M	28	
	Landers Wide Angle Surgical Viewing System	OSVS	41		MaxField® 35D Indirect	OI-35M	29	
	Landers Wide Field Temp Keratoprosthesis	OLTK-7.2	50		MaxField® 40D Indirect	OI-40M	29	
	Landers Wide Field Temp Keratoprosthesis	OLTK-8.2	50		MaxField® 54D Indirect	OI-54M	32	
	Landers Wide Field Vitr	OLIV-WF	36		MaxField® 60D Indirect	OI-60M	32	
	Latina SLT Gonio Laser	OLSLT	14		MaxField® 66D Indirect	OI-66M	33	
	Latina SLT Gonio Laser (flange)	OLSLTF	14		MaxField® 72D Indirect	OI-72M	33	
	Layden Suture Lysis Lens	OLSA	12		MaxField® High Mag 78D Indirect	OI-HM-78M	33	
	Lee-Mainster SLO Lens	OSLO60-2	51		MaxField® (Osher) 78D Indirect	OI-78M	34, 51	
	Lens Adapter, HRA 20D	OHLA20	53		MaxField® 84D Indirect	OI-84M	34	
	Lens Cleaning Cloth	OLCC	57		MaxField® Standard 90 Indirect	OI-STD	34	
	Lens Cleaning Cloth, Autoclavable	OLCCA	57		MaxField® Std 90 Large Ring Indirect	OI-STD-M-LR	34	
	Lens Protection Ring Large	OLPR-L	59		MaxField® 100D Indirect	OI-100M	35	
	Lens Protection Ring Medium	OLPR-M	59		MaxField® 120D Indirect	OI-120M	35	
	Lens Protection Ring Ritch Trabeculoplasty	OLPR-RIT	59		MaxLight® High Mag 78 Indirect	OI-HM	31	
	Lens Protection Ring Small	OLPR-S	59		MaxLight® Standard 90 Indirect	OI-STD	32	
	Lens Protection Ring Sussman	OLPR-SUS	59		MaxLight® Standard 90 Large Ring Indirect	OI-STD-LR	32	
	Lens Protection Ring Sussman Large	OLPR-SUS-2	59		MaxLight® Triple Two Panfundus	OI-222	26	
	Luer Tube Assembly	OLTA	58		MaxLight® Ultra Mag 60 Indirect	OI-UM	31	
	Luer Tube Assembly	OLTA-2	58		MaxLight® 14D Indirect	OI-14	26	
	M	Machemer Flat Vitr	OLV-5		43	MaxLight® 18D Indirect	OI-18	26
		Machemer Mag Vitr Infusion (Blue)	OMVI		47	MaxLight® 20D Indirect	OI-20	26
		Machemer Magnifying Vitr	OLV-3		43	MaxLight® 28D Indirect	OI-28	27
Machemer Plus Vitr		OLV-5SR	44	Mori Upright Surgical Gonio Lens	OMUSG	49		
Magna View Gonio		OMVGL	10	N	NMR-K Single Mirror Gonio Diag	OSMG-2	20	
Magna View Gonio (flange)		OMVGLF	10		NMR-K Single Mirror Gonio Laser	OSMGA-2	11	
Magna View Two Mirror Gonio		OMV2G	10	O	132D Indirect Vitr Lens	OIV-132	40	
Magna View Two Mirror Gonio (flange)		OMV2GF	10		132D Indirect Vitr Lens Holder	OIV-H132	40	
Mainster High Magnification		OMRA-HM	7		132D Upright Vitr Lens Holder	OUV-H132-2	40	
Mainster High Magnification (NMR)		OMRA-HM-2	7		1.5X Magna View Gonio	OMVGL-1.5X	10	
Mainster PRP 165		OMRA-PRP-165	5		1.5X Magna View Gonio (w/flange)	OMVGLF-1.5X	10	
Mainster PRP 165-2 (NMR)		OMRA-PRP-165-2	5		Osher MaxField® 78D Indirect	OI-78M	34, 51	
Mainster (Standard) Focal/Grid		OMRA-S	6		Osher Surgical Gonio Post Pole	OOSGP	50	
Mainster (Standard) Focal/Grid (NMR)		OMRA-S-2	6		Osher Surgical Viewing Kit	OSVK	50	
Mainster Wide Field		OMRA-WF	5		P	Parts, SVS	OSVS-xx	41
Mainster Wide Field (NMR)		OMRA-WF-2	5			PDT 1.6X	OPDT	7
Mandelkorn Iridotomy/Capsulotomy		OMIC	15	PDT 1.6X (NMR)		OPDT-2	7	
Mandelkorn Suture Lysis		OMSLA	13	Pediatric Biconcave Vitr		OPV-B	45	
MaxAC® Autoclavable Lens Stand		OI-LSA	31, 57	Pediatric Flat Infusion (Purple)		OPFVI	46	
MaxAC® 20D Indirect		OI-20A	30	Pediatric Flat Vitr		OPV-F	45	
MaxAC® 28D Indirect		OI-28A	30	Pediatric Lens Forceps		OPV-FCP	45	
MaxField® AC 4 Mirror Gonio Diag	O4MAC	22	Pediatric Lens Ring	OPV-R		45		
MaxField® AC 4 Mirror Gonio Diag	O4MAC-15	22						

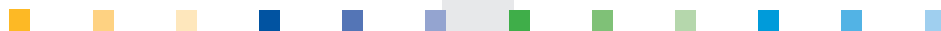

# ALPHABETICAL INDEX



	DESCRIPTION	CODE	PAGE				
P	Pediatric Prism Vitr	OPV-P	45	T	Three Mirror Diag, 17mm OD	OG3MP	18
	Pediatric Reichel-Mainster 1X Retina	ORMR-1X-P	5		Three Mirror Diag, High Definition	OG3MHD-10	8, 19
	Pediatric Vitr Lens Set	OPV-S	45		Three Mirror Diag, High Definition	OG3MHD-15	8, 19
	Peyman-Green Fluid Cell Vitr Infusion (Green)	OPGVI	47		Three Mirror Diag, High Definition	OG3MHD-17	8, 19
	Peyman G. Capsulotomy	OPYG-12-12	15		Three Mirror Diag, Short, 18mm OD	OG3MS	18
	Peyman III Wide Field Vitr Infusion (Gold)	OPVI-3	47		Three Mirror Diag, Short, 16mm OD (NMR)	OG3MS-2	18
	Peyman Pediatric Wide Field	OPPWV	48		Three Mirror Diag, Universal, 18mm OD	OG3M	18
	Peyman Wide Field Vitr	OLV-4	43		Three Mirror Diag, w/flange, 20mm OD	OG3MF	18
	Peyman Wide Field YAG, 12.5mm	OPY-12.5	16		Three Mirror Laser, 13mm OD (NMR)	OG3MA-13	8
	Peyman Wide Field YAG, 18mm	OPY-18	16		Three Mirror Laser, 15mm OD	OG3MIA	8
	Peyman Wide Field YAG, 25mm	OPY-25	16		Three Mirror Laser, 17mm OD	OG3MPA	8
	Peyman-Wessels-Landers Upright 132D	OUV-132-2	40		Three Mirror Laser, High Definition	OG3MHD-10	8, 19
	Pollack Iridotomy/Gonio	OPIG	15		Three Mirror Laser, High Definition	OG3MHD-15	8, 19
	Posner Diag/Gonioprism	OPDSG	23		Three Mirror Laser, High Definition	OG3MHD-17	8, 19
	Posner Diag/Gonioprism	OPDSG-2	23		Three Mirror Laser, Short, 18mm OD	OG3MSA	8
	Posner Diag/Gonioprism	OPDSG-3	23		Three Mirror Laser, Universal, 18mm OD	OG3MA	8
	Proretina 120 PB	OPR-120	6		Three Mirror Laser, w/flange, 20mm OD	OG3MFA	8
	Proretina 120 PB NMR	OPR-120-2	6		Three Mirror Laser, 16mm OD NMR	OG3MA-2	8
R	Reichel-Mainster 1X Retina	ORMR-1X	5	Three Mirror Laser, Short, 16mm OD NMR	OG3MSA-2	8	
	Reichel-Mainster 2X Retina	ORMR-2X	6	Three Mirror Lens Flange	OACF-15	57	
	Reichel-Mainster 1X Retina (NMR)	ORMR-1X-2	5	Three Mirror Lens Flange	OACF-17	57	
	Reichel-Mainster 2X Retina (NMR)	ORMR-2X-2	6	Tolentino 20° Prism	OLV-6	43	
	Reichel-Mainster 1X Retina (Pediatric)	ORMR-1X-P	5	Tolentino 30° Prism	OLV-7	43	
	Reichel Vitrectomy Lens Holder	ORVLH	44	Two Mirror Gonio Diag	O2M	20	
	Reichel Viscous Contact Systems	ORVCS	39	Two Mirror Gonio Diag (flange)	O2MF	20	
	Ring, Protection, Large	OLPR-L	59	Two Mirror Gonio Diag (NMR-K)	O2M-2	20	
	Ring, Protection, Medium	OLPR-M	59	Two Mirror Gonio Laser	O2MA	11	
	Ring, Protection, Ritch Trabeculoplasty	OLPR-RIT	59	Two Mirror Gonio Laser (flange)	O2MFA	11	
	Ring, Protection, Small	OLPR-S	59	Two Mirror Gonio Laser (NMR)	O2MA-2	11	
	Ring, Protection, Sussman	OLPR-SUS	59				
	Ring, Protection, Sussman, Large	OLPR-SUS-2	59	U	Ultra View SP 132D Indirect	OI-SP	35
	Ritch Nylon Suture	ORNSA	13	V	Vitr Lens Case, AC	OLV-C4	56
	Ritch Panoramic Surgical Gonioprism	ORPSG	49		Vitr Lens Case, 2 Lens	OLV-C2	56
	Ritch Trabeculoplasty	ORTA	12	Vitr Lens Case, 8 Lens	OLV-C	56	
	Rubber Adjustment Knob, IVS	OIVS-K	38	Vitr Lens Case, 10 Lens	OLV-C3	56	
	S	Saxena Refinal Grid 428	OI-SRG428	29	Vitr Lens Case, 10 Lens	OLV-C3-HRI	56
Saxena Retinal Grid 520		OI-SRG520	30	W	Wells Suture Manipulator Lens	OWSM	49
Screw Driver, Slotted, IVS		OIVS-SD	38		Wide Angle Vitr Lens Handle	OLIV-H	38
Single Mirror Gonio Diag		OSMG	20		Wise Iridotomy-Sphincterotomy	OWISA	9
Single Mirror Gonio Diag (flange)		OSMGF	20		Woldoff High Magnification	OWIV-HM	36
Single Mirror Gonio Diag (NMR-K)		OSMG-2	20		Woldoff NA High Magnification	OWIV-HMNA	37
Single Mirror Gonio Laser		OSMGA	11		Woldoff Prismatic Biconcave	OLV-9	43
Single Mirror Gonio Laser (flange)		OSMGFA	11		Y	Yannuzzi Fundus Laser	OYFA
Single Mirror Gonio Laser (NMR-K)		OSMGA-2	11				
Starengi 230 SLO Retina Lens		OSR230	51				
Surgical Viewing System Case		OIVS-C	38, 56				
Surgical Viewing System Case		OSVS-C	41, 56				
Sussman 4 Mirror Gonioscope Diag		OS4M	23				
Sussman 4 Mirror Gonioscope Diag		OS4M-2	23				
SVS Parts	OSVS-xx	41					
Swan-Jacob Autoclavable Gonioprism	OSJAG	49					
T	2mm Fundus Laser Lens	OFA2.0	52				
	2mm Gonioprism Research	OGP2	52				
	2mm Gonioprism Research	OGP2H	52				
	Tano Vitr Lens Ring	OTN-R	44				
	Thorpe Four Mirror Gonio Diag	OT4MG	23				
	Thorpe Four Mirror Gonio Laser	OT4MGA	12				
	Three Mirror 10mm Gonio Diag (NMR)	OG3M-10	19				
	Three Mirror Diag, 13mm OD (NMR)	OG3M-13	18				
	Three Mirror Diag, 15mm OD	OG3MI	18				
	Three Mirror Diag, 16mm OD (NMR)	OG3M-2	18				

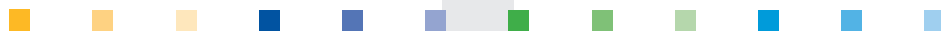



 **HOW TO REACH US**

Mail, Shipments, Visitors:

**OCULAR INSTRUMENTS INC**

2255 116th Avenue NE  
Bellevue, WA 98004-3039 USA

**TELEPHONE: 425-455-5200**

Toll-free USA: 800-888-6616

Fax: 425-462-6669

Email: [contact@ocularinc.com](mailto:contact@ocularinc.com)

Internet: [www.ocularinc.com](http://www.ocularinc.com)

# Future



Ocular offers so many products because of our more than 40 year working relationship with ophthalmologists around the world. We have worked with you and your ideas to create new and innovative products to keep up with the changing needs of the industry.

We are honored by the longstanding relationships we maintain with many ophthalmologists of great prominence, whose names are associated with many ocular lenses used daily throughout the world.

Share your new product ideas with Ocular's Research and Development department. We consider it a privilege to work with you to advance the profession of ophthalmology. And who knows – your name could be the next to appear on an Ocular product!

We look forward to hearing from you. If you have a product idea, contact our R&D department:

Toll-Free: (800) 888-6616

Stay up-to-date on the latest Ocular products and innovations by signing up for our e-newsletter at: [ocularinc.com](http://ocularinc.com)





**TOLL-FREE USA** (800) 888-6616 | [contact@ocularinc.com](mailto:contact@ocularinc.com) | [ocularinc.com](http://ocularinc.com)  
2255 116<sup>TH</sup> Avenue North East, Bellevue, Washington 98004-3039 USA



©2011 Ocular Instruments



SEE TABLE OF CONTENTS FOR **CE**  
CERTIFICATION INFORMATION